

CD4007M/CD4007C Dual Complementary Pair Plus Inverter

General Description

The CD4007M/CD4007C consists of three complementary pairs of N- and P-channel enhancement mode MOS transistors suitable for series/shunt applications. All inputs are protected from static discharge by diode clamps to V_{DD} and V_{SS} .

For proper operation the voltages at all pins must be constrained to be between $V_{SS} - 0.3V$ and $V_{DD} + 0.3V$ at all times.

Features

- Wide supply voltage range
- High noise immunity

3.0V to 15V
0.45 V_{CC} (typ.)

Connection Diagram

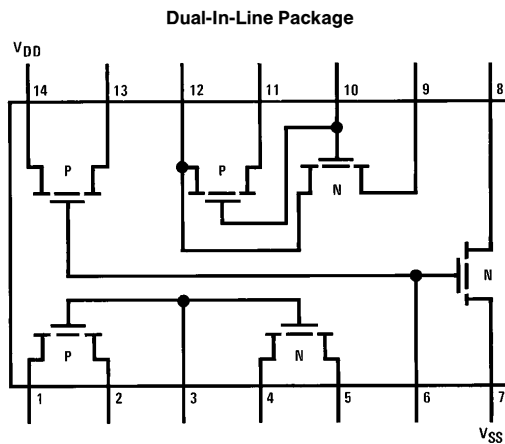

TL/F/5943-1

Top View

Note: All P-channel substrates are connected to V_{DD} and all N-channel substrates are connected to V_{SS} .

Order Number CD4007

Absolute Maximum Ratings (Note 1)

If Military/Aerospace specified devices are required, please contact the National Semiconductor Sales Office/Distributors for availability and specifications.

Voltage at Any Pin $V_{SS} - 0.3V$ to $V_{DD} + 0.3V$

Operating Temperature Range
 CD4007M $-55^{\circ}C$ to $+125^{\circ}C$
 CD4007C $-40^{\circ}C$ to $+85^{\circ}C$

Storage Temperature Range $-65^{\circ}C$ to $+150^{\circ}C$

Power Dissipation (P_D)
 Dual-In-Line 700 mW
 Small Outline 500 mW

Operating V_{DD} Range $V_{SS} + 3.0V$ to $V_{SS} + 15V$

Lead Temperature (Soldering, 10 seconds) 260°C

DC Electrical Characteristics CD4007M

Symbol	Parameter	Conditions	Limits									Units
			$-55^{\circ}C$			$+25^{\circ}C$			$+125^{\circ}C$			
			Min	Typ	Max	Min	Typ	Max	Min	Typ	Max	
I_L	Quiescent Device Current	$V_{DD} = 5.0V$ $V_{DD} = 10V$			0.05		0.001	0.05			3.0	μA
					0.1		0.001	0.1			6.0	μA
P_D	Quiescent Device Dissipation Package	$V_{DD} = 5.0V$ $V_{DD} = 10V$			0.25		0.005	0.25			15	μW
					1.0		0.001	1.0			60	μW
V_{OL}	Output Voltage Low Level	$V_{DD} = 5.0V$ $V_{DD} = 10V$			0.05		0	0.05			0.05	V
					0.05		0	0.05			0.05	V
V_{OH}	Output Voltage High Level	$V_{DD} = 5.0V$ $V_{DD} = 10V$	4.95		4.95	5.0		4.95				V
			9.95		9.95	10		9.95				V
V_{NL}	Noise Immunity (All Inputs)	$V_{DD} = 5.0V, V_O = 3.6V$ $V_{DD} = 10V, V_O = 7.2V$			1.5		2.25	1.5			1.4	V
					3.0		4.5	3.0			2.9	V
V_{NH}	Noise Immunity (All Inputs)	$V_{DD} = 5.0V, V_O = 0.95V$ $V_{DD} = 10V, V_O = 2.9V$	3.6		3.5	2.25		3.5				V
			7.1		7.0	4.5		7.0				V
I_{DN}	Output Drive Current N-Channel	$V_{DD} = 5.0V, V_O = 0.4V, V_I = V_{DD}$ $V_{DD} = 10V, V_O = 0.5V, V_I = V_{DD}$	0.75		0.6	1.0		0.4				mA
			1.6		1.3	2.5		0.95				mA
I_{DP}	Output Drive Current P-Channel	$V_{DD} = 5.0V, V_O = 2.5V, V_I = V_{SS}$ $V_{DD} = 10V, V_O = 9.5V, V_I = V_{SS}$	-1.75		-1.4	-4.0		-1.0				mA
			-1.35		-1.1	-2.5		-0.75				mA
I_I	Input Current					10					pA	

DC Electrical Characteristics CD4007C

Symbol	Parameter	Conditions	Limits									Units
			$-40^{\circ}C$			$+25^{\circ}C$			$+85^{\circ}C$			
			Min	Typ	Max	Min	Typ	Max	Min	Typ	Max	
I_L	Quiescent Device Current	$V_{DD} = 5.0V$ $V_{DD} = 10V$			0.5		0.005	0.05			15	μA
					1.0		0.005	1.0			30	μA
P_D	Quiescent Device Dissipation Package	$V_{DD} = 5.0V$ $V_{DD} = 10V$			2.5		0.025	2.5			75	μW
					10		0.05	10			300	μW
V_{OL}	Output Voltage Low Level	$V_{DD} = 5.0V$ $V_{DD} = 10V$			0.05		0	0.01			0.05	V
					0.05		0	0.01			0.05	V
V_{OH}	Output Voltage High Level	$V_{DD} = 5.0V$ $V_{DD} = 10V$	4.95		4.95	5.0		4.95				V
			9.95		9.95	10		9.95				V
V_{NL}	Noise Immunity (All inputs)	$V_{DD} = 5.0V, V_O = 3.6V$ $V_{DD} = 10V, V_O = 7.2V$			1.5		2.25	1.5			1.4	V
					3.0		4.5	3.0			2.9	V
V_{NH}	Noise Immunity (All Inputs)	$V_{DD} = 5.0V, V_O = 0.95V$ $V_{DD} = 10V, V_O = 2.9V$	3.6		3.5	2.25		3.5				V
			7.1		7.0	4.5		7.0				V
I_{DN}	Output Drive Current N-Channel	$V_{DD} = 5.0V, V_O = 0.4V, V_I = V_{DD}$ $V_{DD} = 10V, V_O = 0.5V, V_I = V_{DD}$	0.35		0.3	1.0		0.24				mA
			1.2		1.0	2.5		0.8				mA
I_{DP}	Output Drive Current P-Channel	$V_{DD} = 5.0V, V_O = 2.5V, V_I = V_{SS}$ $V_{DD} = 10V, V_O = 9.5V, V_I = V_{SS}$	-1.3		-1.1	-4.0		-0.9				mA
			-0.65		-0.55	-2.5		-0.45				mA
I_I	Input Current					10					pA	

Note 1: This device should not be connected to circuits with the power on because high transient voltages may cause permanent damage.

AC Electrical Characteristics* CD4007M

$T_A = 25^\circ\text{C}$ and $C_L = 15\text{ pF}$ and rise and fall times = 20 ns. Typical temperature coefficient for all values of $V_{DD} = 0.3\%/^\circ\text{C}$

Symbol	Parameter	Conditions	Min	Typ	Max	Units
$t_{PLH} = t_{PHL}$	Propagation Delay Time	$V_{DD} = 5.0\text{V}$		35	60	ns
		$V_{DD} = 10\text{V}$		20	40	ns
$t_{TLH} = t_{THL}$	Transition Time	$V_{DD} = 5.0\text{V}$		50	75	ns
		$V_{DD} = 10\text{V}$		30	40	ns
C_i	Input Capacitance	Any Input		5.0		pF

*AC Parameters may be generated by DC correlated testing.

AC Electrical Characteristics* CD4007C

$T_A = 25^\circ\text{C}$ and $C_L = 15\text{ pF}$ and rise and fall times = 20 ns. Typical temperature coefficient for all values of $V_{DD} = 0.3\%/^\circ\text{C}$

Symbol	Parameter	Conditions	Min	Typ	Max	Units
$t_{PLH} = t_{PHL}$	Propagation Delay Time	$V_{DD} = 5.0\text{V}$		35	75	ns
		$V_{DD} = 10\text{V}$		20	50	ns
$t_{TLH} = t_{THL}$	Transition Time	$V_{DD} = 5.0\text{V}$		50	100	ns
		$V_{DD} = 10\text{V}$		30	50	ns
C_i	Input Capacitance	Any Input		5		pF

*AC Parameters are guaranteed by DC correlated testing.

AC Test Circuits

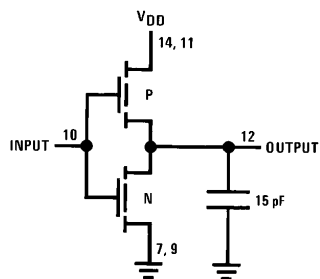

TL/F/5943-2

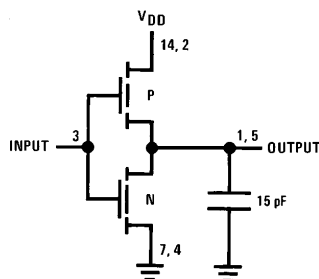

TL/F/5943-3

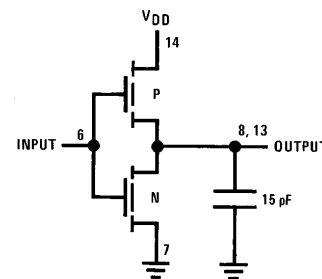

TL/F/5943-4

Switching Time Waveforms

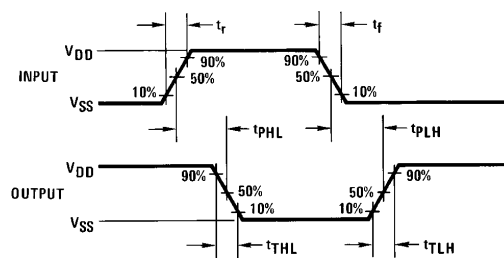

TL/F/5943-5

Physical Dimensions inches (millimeters)

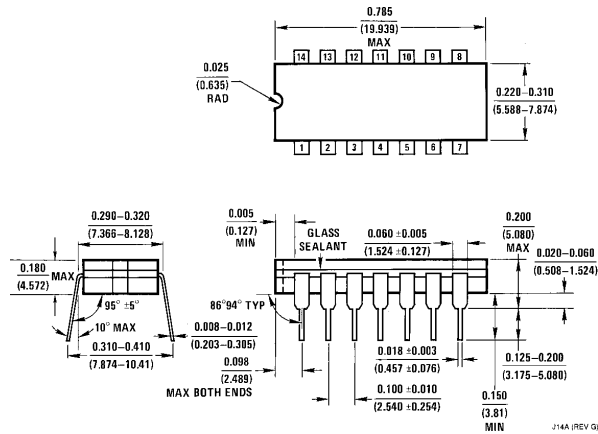

Ceramic Dual-In-Line Package (J)
Order Number CD4007MJ or CD4007CJ
NS Package Number J14A

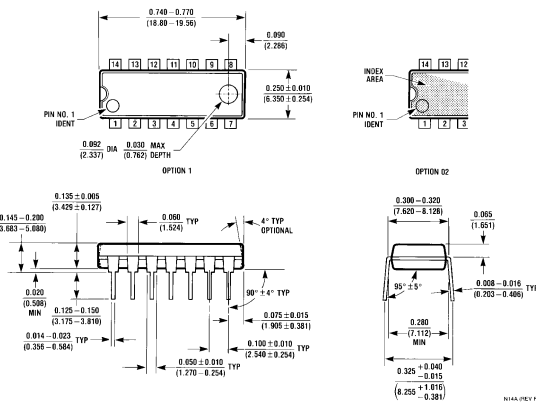

Molded Dual-In-Line Package (N)
Order Number CD4007MN or CD4007CN
NS Package Number N14A

LIFE SUPPORT POLICY

NATIONAL'S PRODUCTS ARE NOT AUTHORIZED FOR USE AS CRITICAL COMPONENTS IN LIFE SUPPORT DEVICES OR SYSTEMS WITHOUT THE EXPRESS WRITTEN APPROVAL OF THE PRESIDENT OF NATIONAL SEMICONDUCTOR CORPORATION. As used herein:

1. Life support devices or systems are devices or systems which, (a) are intended for surgical implant into the body, or (b) support or sustain life, and whose failure to perform, when properly used in accordance with instructions for use provided in the labeling, can be reasonably expected to result in a significant injury to the user.
2. A critical component is any component of a life support device or system whose failure to perform can be reasonably expected to cause the failure of the life support device or system, or to affect its safety or effectiveness.

 <p>National Semiconductor Corporation 1111 West Bardin Road Arlington, TX 76017 Tel: 1(800) 272-9959 Fax: 1(800) 737-7018</p>	<p>National Semiconductor Europe Fax: (+49) 0-180-530 85 86 Email: cnjwge@tevm2.nsc.com Deutsch Tel: (+49) 0-180-530 85 85 English Tel: (+49) 0-180-532 78 32 Français Tel: (+49) 0-180-532 93 58 Italiano Tel: (+49) 0-180-534 16 80</p>	<p>National Semiconductor Hong Kong Ltd. 19th Floor, Straight Block, Ocean Centre, 5 Canton Rd. Tsimshatsui, Kowloon Hong Kong Tel: (852) 2737-1600 Fax: (852) 2736-9960</p>	<p>National Semiconductor Japan Ltd. Tel: 81-043-299-2309 Fax: 81-043-299-2408</p>
--	--	---	---

National does not assume any responsibility for use of any circuitry described, no circuit patent licenses are implied and National reserves the right at any time without notice to change said circuitry and specifications.