

CD4014BM/CD4014BC 8-Stage Static Shift Register

General Description

The CD4014BM/CD4014BC is an 8-stage parallel input/serial output shift register. A parallel/serial control input enables individual JAM inputs to each of 8 stages. Q outputs are available from the sixth, seventh and eighth stages. All outputs have equal source and sink current capabilities and conform to standard "B" series output drive.

When the parallel/serial control input is in the logical "0" state, data is serially shifted into the register synchronously with the positive transition of the clock. When the parallel/serial control input is in the logical "1" state, data is jammed into each stage of the register synchronously with the positive transition of the clock.

All inputs are protected against static discharge with diodes to V_{DD} and V_{SS} .

Features

- Wide supply voltage range 3.0V to 15V
- High noise immunity 0.45 V_{DD} (typ.)
- Low power TTL compatibility Fan out of 2 driving 74L or 1 driving 74LS
- 5V–10V–15V parametric ratings
- Symmetrical output characteristics
- Maximum input leakage: 1 μ A at 15V over full temperature range

Connection Diagram

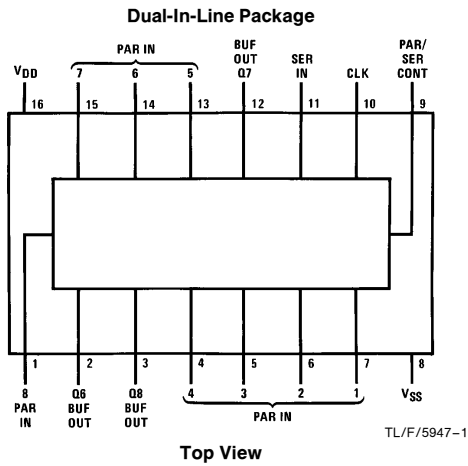

Truth Table

| CL* | Serial Input | Parallel/Serial Control | PI 1 | PI n | Q1 (Internal) | Qn |
|-----|--------------|-------------------------|------|------|---------------|-----------|
| ↗ | X | 1 | 0 | 0 | 0 | 0 |
| ↘ | X | 1 | 1 | 0 | 1 | 0 |
| ↗ | X | 1 | 0 | 1 | 0 | 1 |
| ↘ | X | 1 | 1 | 1 | 1 | 1 |
| ↗ | 0 | 0 | X | X | 0 | Q_{n-1} |
| ↘ | 1 | 0 | X | X | 1 | Q_{n-1} |
| ↗ | X | X | X | X | Q1 | Q_n |

No Change

*Level change
X = Don't care case

Order Number CD4014B

Logic Diagram

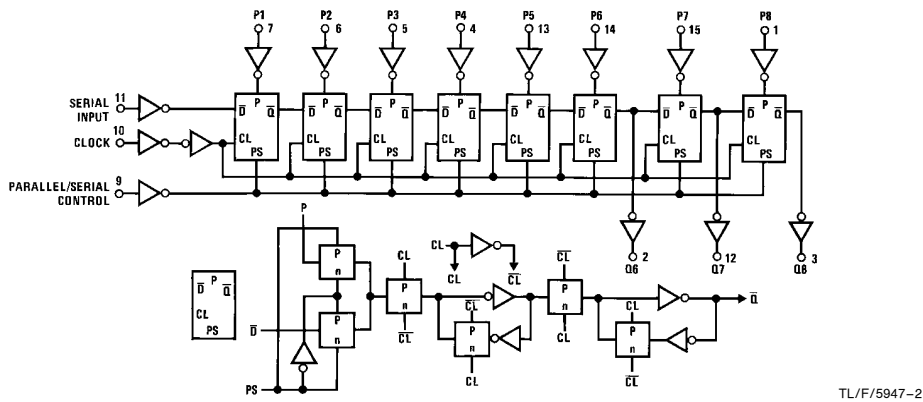

Absolute Maximum Ratings (Notes 1 & 2)

If Military/Aerospace specified devices are required, please contact the National Semiconductor Sales Office/Distributors for availability and specifications.

| | |
|-------------------------------------|-------------------------|
| Supply Voltage (V_{DD}) | -0.5V to +18V |
| Input Voltage (V_{IN}) | -0.5 to V_{DD} + 0.5V |
| Storage Temperature Range (T_S) | -65°C to +150°C |
| Power Dissipation (P_D) | |
| Dual-In-Line | 700 mW |
| Small Outline | 500 mW |
| Lead Temperature (T_L) | |
| (Soldering, 10 seconds) | 260°C |

Recommended Operating Conditions (Note 2)

| | |
|---------------------------------------|-----------------|
| Supply Voltage (V_{DD}) | 3.0V to 15V |
| Input Voltage (V_{IN}) | 0 to V_{DD} |
| Operating Temperature Range (T_A) | |
| CD4014BM | -55°C to +125°C |
| CD4014BC | -40°C to +85°C |

DC Electrical Characteristics CD4014BM (Note 2)

| Symbol | Parameter | Conditions | -55°C | | +25°C | | | +125°C | | Units |
|----------|------------------------------------|--|-------|-------|-------|------------|-------|--------|------|---------|
| | | | Min | Max | Min | Typ | Max | Min | Max | |
| I_{DD} | Quiescent Device Current | $V_{DD} = 5V, V_{IN} = V_{DD}$ or V_{SS} | | 5 | | 0.1 | 5 | | 150 | μA |
| | | $V_{DD} = 10V, V_{IN} = V_{DD}$ or V_{SS} | | 10 | | 0.2 | 10 | | 300 | μA |
| | | $V_{DD} = 15V, V_{IN} = V_{DD}$ or V_{SS} | | 20 | | 0.3 | 20 | | 600 | μA |
| V_{OL} | Low Level Output Voltage | $V_{DD} = 5V$ $V_{DD} = 10V$ $V_{DD} = 15V$ } $ I_O < 1 \mu A$ | | 0.05 | | 0 | 0.05 | | 0.05 | V |
| | | | | 0.05 | | 0 | 0.05 | | 0.05 | V |
| | | | | 0.05 | | 0 | 0.05 | | 0.05 | V |
| V_{OH} | High Level Output Voltage | $V_{DD} = 5V$ $V_{DD} = 10V$ $V_{DD} = 15V$ } $ I_O < 1 \mu A$ | 4.95 | | 4.95 | 5 | | 4.95 | | V |
| | | | 9.95 | | 9.95 | 10 | | 9.95 | | V |
| | | | 14.95 | | 14.95 | 15 | | 14.95 | | V |
| V_{IL} | Low Level Input Voltage | $V_{DD} = 5V, V_O = 0.5V$ or 4.5V $V_{DD} = 10V, V_O = 1.0V$ or 9.0V $V_{DD} = 15V, V_O = 1.5V$ or 13.5V | | 1.5 | | 2 | 1.5 | | 1.5 | V |
| | | | | 3.0 | | 4 | 3.0 | | 3.0 | V |
| | | | | 4.0 | | 6 | 4.0 | | 4.0 | V |
| V_{IH} | High Level Input Voltage | $V_{DD} = 5V, V_O = 0.5V$ or 4.5V $V_{DD} = 10V, V_O = 1.0V$ or 9.0V $V_{DD} = 15V, V_O = 1.5V$ or 13.5V | 3.5 | | 3.5 | 3 | | 3.5 | | V |
| | | | 7.0 | | 7.0 | 6 | | 7.0 | | V |
| | | | 11.0 | | 11.0 | 9 | | 11.0 | | V |
| I_{OL} | Low Level Output Current (Note 3) | $V_{DD} = 5V, V_O = 0.4V$ $V_{DD} = 10V, V_O = 0.5V$ $V_{DD} = 15V, V_O = 1.5V$ | 0.64 | | 0.51 | 0.88 | | 0.36 | | mA |
| | | | 1.6 | | 1.3 | 2.2 | | 0.9 | | mA |
| | | | 4.2 | | 3.4 | 8 | | 2.4 | | mA |
| I_{OH} | High Level Output Current (Note 3) | $V_{DD} = 5V, V_O = 4.6V$ $V_{DD} = 10V, V_O = 9.5V$ $V_{DD} = 15V, V_O = 13.5V$ | -0.64 | | -0.51 | -0.88 | | -0.36 | | mA |
| | | | -1.6 | | -1.3 | -2.2 | | -0.9 | | mA |
| | | | -4.2 | | -3.4 | -8 | | -2.4 | | mA |
| I_{IN} | Input Current | $V_{DD} = 15V, V_{IN} = 0V$ $V_{DD} = 15V, V_{IN} = 15V$ | | -0.10 | | -10^{-5} | -0.10 | | -1.0 | μA |
| | | | | 0.10 | | 10^{-5} | 0.10 | | 1.0 | μA |

DC Electrical Characteristics CD4014BC (Note 2)

| Symbol | Parameter | Conditions | -40°C | | +25°C | | | +85°C | | Units |
|----------|-----------------------------------|--|-------|------|-------|------|------|-------|------|---------|
| | | | Min | Max | Min | Typ | Max | Min | Max | |
| I_{DD} | Quiescent Device Current | $V_{DD} = 5V, V_{IN} = V_{DD}$ or V_{SS} $V_{DD} = 10V, V_{IN} = V_{DD}$ or V_{SS} $V_{DD} = 15V, V_{IN} = V_{DD}$ or V_{SS} | | 20 | | 0.1 | 20 | | 150 | μA |
| | | | | 40 | | 0.2 | 40 | | 300 | μA |
| | | | | 80 | | 0.3 | 80 | | 600 | μA |
| V_{OL} | Low Level Output Voltage | $V_{DD} = 5V$ $V_{DD} = 10V$ $V_{DD} = 15V$ } $ I_O < 1 \mu A$ | | 0.05 | | 0 | 0.05 | | 0.05 | V |
| | | | | 0.05 | | 0 | 0.05 | | 0.05 | V |
| | | | | 0.05 | | 0 | 0.05 | | 0.05 | V |
| V_{OH} | High Level Output Voltage | $V_{DD} = 5V$ $V_{DD} = 10V$ $V_{DD} = 15V$ } $ I_O < 1 \mu A$ | 4.95 | | 4.95 | 5 | | 4.95 | | V |
| | | | 9.95 | | 9.95 | 10 | | 9.95 | | V |
| | | | 14.95 | | 14.95 | 15 | | 14.95 | | V |
| V_{IL} | Low Level Input Voltage | $V_{DD} = 5V, V_O = 0.5V$ or 4.5V $V_{DD} = 10V, V_O = 1.0V$ or 9.0V $V_{DD} = 15V, V_O = 1.5V$ or 13.5V | | 1.5 | | 2 | 1.5 | | 1.5 | V |
| | | | | 3.0 | | 4 | 3.0 | | 3.0 | V |
| | | | | 4.0 | | 6 | 4.0 | | 4.0 | V |
| V_{IH} | High Level Input Voltage | $V_{DD} = 5V, V_O = 0.5V$ or 4.5V $V_{DD} = 10V, V_O = 1.0V$ or 9.0V $V_{DD} = 15V, V_O = 1.5V$ or 13.5V | 3.5 | | 3.5 | 3 | | 3.5 | | V |
| | | | 7.0 | | 7.0 | 6 | | 7.0 | | V |
| | | | 11.0 | | 11.0 | 9 | | 11.0 | | V |
| I_{OL} | Low Level Output Current (Note 3) | $V_{DD} = 5V, V_O = 0.4V$ $V_{DD} = 10V, V_O = 0.5V$ $V_{DD} = 15V, V_O = 1.5V$ | 0.52 | | 0.44 | 0.88 | | 0.36 | | mA |
| | | | 1.3 | | 1.1 | 2.2 | | 0.9 | | mA |
| | | | 3.6 | | 3.0 | 8 | | 2.4 | | mA |

DC Electrical Characteristics CD4014BC (Note 2) (Continued)

| Symbol | Parameter | Conditions | −40°C | | +25°C | | | +85°C | | Units |
|-----------------|------------------------------------|---|-------|------|-------|-------------------|------|-------|------|----------------|
| | | | Min | Max | Min | Typ | Max | Min | Max | |
| I _{OH} | High Level Output Current (Note 3) | V _{DD} = 5V, V _O = 4.6V | −0.52 | | −0.44 | −0.88 | | −0.36 | | mA mA mA |
| | | V _{DD} = 10V, V _O = 9.5V | −1.3 | | −1.1 | −2.2 | | −0.90 | | |
| | | V _{DD} = 15V, V _O = 13.5V | −3.6 | | −3.0 | −8 | | −2.4 | | |
| I _{IN} | Input Current | V _{DD} = 15V, V _{IN} = 0V | | −0.3 | | −10 ^{−5} | −0.3 | | −1.0 | μA μA |
| | | V _{DD} = 15V, V _{IN} = 15V | | 0.3 | | 10 ^{−5} | 0.3 | | 1.0 | |

AC Electrical Characteristics* T_A = 25°C, input t_r, t_f = 20 ns, C_L = 50 pF, R_L = 200 kΩ

| Symbol | Parameter | Conditions | Min | Typ | Max | Units |
|--|---|-----------------------|-----|-----|-----|-------|
| t _{PHL} , t _{PLH} | Propagation Delay Time | V _{DD} = 5V | | 200 | 320 | ns |
| | | V _{DD} = 10V | | 80 | 160 | ns |
| | | V _{DD} = 15V | | 60 | 120 | ns |
| t _{THL} , t _{TLH} | Transition Time | V _{DD} = 5V | | 100 | 200 | ns |
| | | V _{DD} = 10V | | 50 | 100 | ns |
| | | V _{DD} = 15V | | 40 | 80 | ns |
| f _{CL} | Maximum Clock Input Frequency | V _{DD} = 5V | 2.8 | 4 | | MHz |
| | | V _{DD} = 10V | 6 | 12 | | MHz |
| | | V _{DD} = 15V | 8 | 16 | | MHz |
| t _w | Minimum Clock Pulse Width | V _{DD} = 5V | | 90 | 180 | ns |
| | | V _{DD} = 10V | | 40 | 80 | ns |
| | | V _{DD} = 15V | | 25 | 50 | ns |
| t _{rCL} , t _{fCL} | Clock Rise and Fall Time (Note 4) | V _{DD} = 5V | | | 15 | μs |
| | | V _{DD} = 10V | | | 15 | μs |
| | | V _{DD} = 15V | | | 15 | μs |
| t _S | Minimum Set-Up Time (Note 6) Serial Input t _H ≥ 200 ns | V _{DD} = 5V | | 60 | 120 | ns |
| | | V _{DD} = 10V | | 40 | 80 | ns |
| | | V _{DD} = 15V | | 30 | 60 | ns |
| | Parallel Inputs t _H ≥ 200 ns | V _{DD} = 5V | | 80 | 160 | ns |
| | | V _{DD} = 10V | | 40 | 80 | ns |
| | | V _{DD} = 15V | | 30 | 60 | ns |
| Parallel/Serial Control t _H ≥ 200 ns | V _{DD} = 5V | | 100 | 200 | ns | |
| | V _{DD} = 10V | | 50 | 100 | ns | |
| | V _{DD} = 15V | | 40 | 80 | ns | |
| t _H | Minimum Hold Time Serial In, Parallel In, t _S ≥ 400 ns Parallel/Serial Control | V _{DD} = 5V | | | 0 | ns |
| | | V _{DD} = 10V | | | 10 | ns |
| | | V _{DD} = 15V | | | 15 | ns |
| C _I | Average Input Capacitance (Note 5) | Any Input | | 5 | 7.5 | pF |
| C _{PD} | Power Dissipation Capacitance (Note 5) | | | 110 | | pF |

*AC Parameters are guaranteed by DC correlated testing.

Note 1: "Absolute Maximum Ratings" are those values beyond which the safety of the device cannot be guaranteed. Except for "Operating Temperature Range" they are not meant to imply that the devices should be operated at these limits. The table of "Electrical Characteristics" provides conditions for actual device operation.

Note 2: V_{SS} = 0V unless otherwise specified.

Note 3: I_{OL} and I_{OH} are tested one output at a time.

Note 4: If more than one unit is cascaded t_{rCL} should be made less than or equal to the fixed propagation delay of the output of the driving stage for the estimated capacitive load.

Note 5: C_{PD} determines the no load AC power consumption of any CMOS device. For complete explanation, see 54C/74C family characteristics application note AN-90.

Note 6: Setup times are measured with reference to clock and a fixed hold time (t_H) as specified.

Typical Performance Characteristics

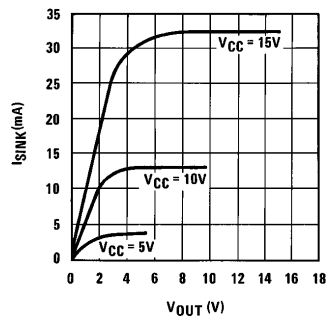

TL/F/5947-3

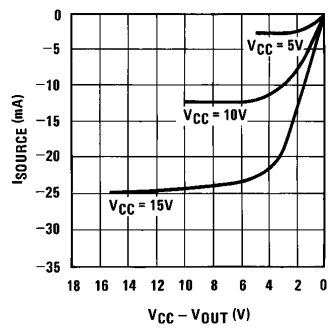

TL/F/5947-4

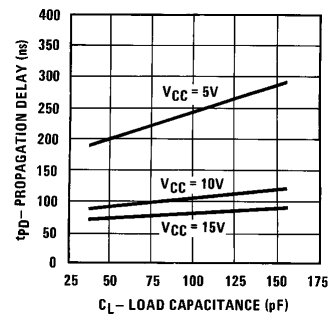

TL/F/5947-5

Physical Dimensions inches (millimeters)

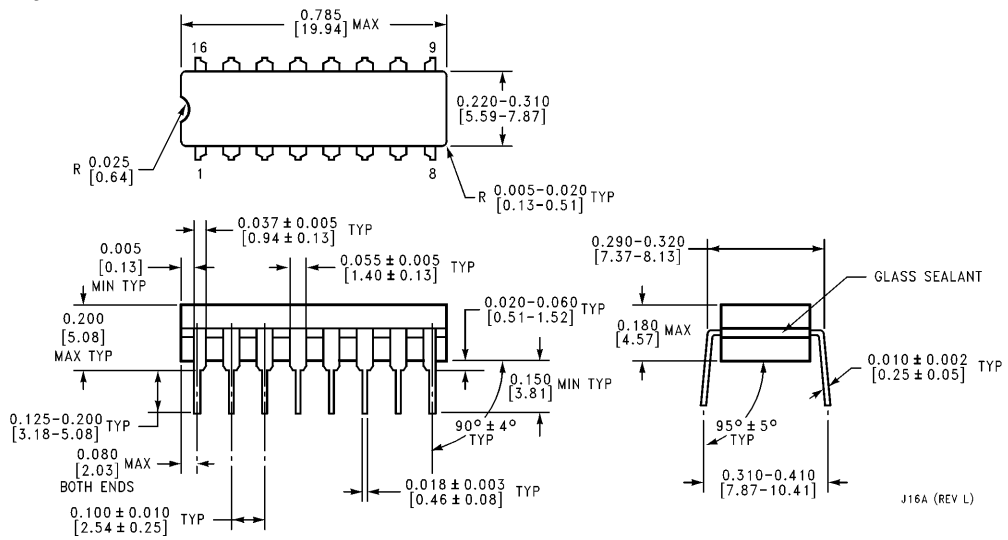

Ceramic Dual-In-Line Package (J)
Order Number CD4014BMJ or CD4014BCJ
NS Package Number J16A

J16A (REV L)

Physical Dimensions inches (millimeters) (Continued)

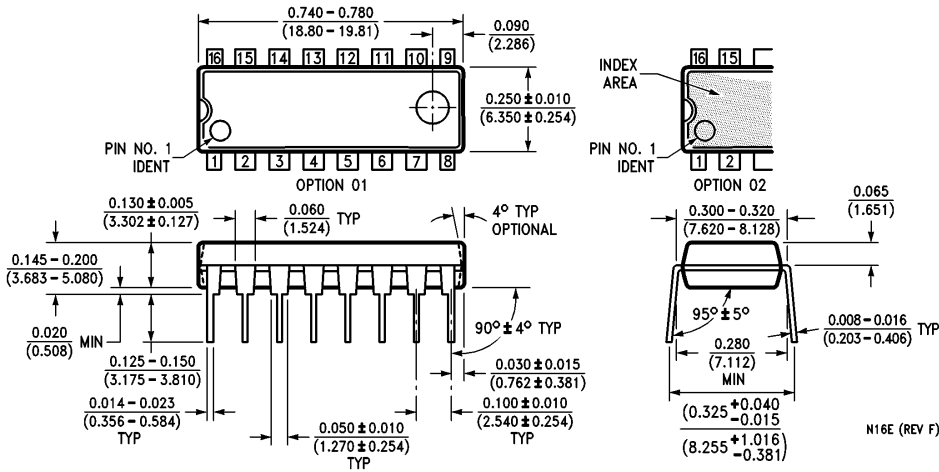

Molded Dual-In-Line Package (N)
Order Number CD4014BMN or CD4014BCN
NS Package Number N16E

LIFE SUPPORT POLICY

NATIONAL'S PRODUCTS ARE NOT AUTHORIZED FOR USE AS CRITICAL COMPONENTS IN LIFE SUPPORT DEVICES OR SYSTEMS WITHOUT THE EXPRESS WRITTEN APPROVAL OF THE PRESIDENT OF NATIONAL SEMICONDUCTOR CORPORATION. As used herein:

1. Life support devices or systems are devices or systems which, (a) are intended for surgical implant into the body, or (b) support or sustain life, and whose failure to perform, when properly used in accordance with instructions for use provided in the labeling, can be reasonably expected to result in a significant injury to the user.
2. A critical component is any component of a life support device or system whose failure to perform can be reasonably expected to cause the failure of the life support device or system, or to affect its safety or effectiveness.



National Semiconductor Corporation
 1111 West Bardin Road
 Arlington, TX 76017
 Tel: 1(800) 272-9959
 Fax: 1(800) 737-7018

National Semiconductor Europe
 Fax: (+49) 0-180-530 85 86
 Email: cnjwge@tevm2.nsc.com
 Deutsch Tel: (+49) 0-180-530 85 85
 English Tel: (+49) 0-180-532 78 32
 Français Tel: (+49) 0-180-532 93 58
 Italiano Tel: (+49) 0-180-534 16 80

National Semiconductor Hong Kong Ltd.
 19th Floor, Straight Block,
 Ocean Centre, 5 Canton Rd.
 Tsimshatsui, Kowloon
 Hong Kong
 Tel: (852) 2737-1600
 Fax: (852) 2736-9960

National Semiconductor Japan Ltd.
 Tel: 81-043-299-2309
 Fax: 81-043-299-2408

National does not assume any responsibility for use of any circuitry described, no circuit patent licenses are implied and National reserves the right at any time without notice to change said circuitry and specifications.