



Package: SOT-363



Product Description

The SGA-4363 is a high performance SiGe HBT MMIC Amplifier. A Darlington configuration featuring one-micron emitters provides high F_T and excellent thermal performance. The heterojunction increases breakdown voltage and minimizes leakage current between junctions. Cancellation of emitter junction non-linearities results in higher suppression of intermodulation products. Only two DC-blocking capacitors, a bias resistor, and an optional RF choke are required for operation.

Optimum Technology Matching® Applied

- GaAs HBT
- GaAs MESFET
- InGaP HBT
- SiGe BiCMOS
- Si BiCMOS
- SiGe HBT
- GaAs pHEMT
- Si CMOS
- Si BJT
- GaN HEMT
- RF MEMS

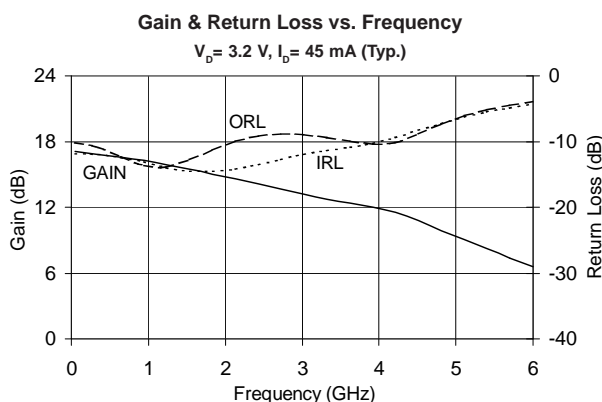

Features

- Available in Lead Free, RoHS Compliant, and Green Packaging (Z Part Number)
- High Gain: 14.8dB at 1950MHz
- Cascadable 50Ω
- Operates from Single Supply
- Low Thermal Resistance Package

Applications

- PA Driver Amplifier
- Cellular, PCS, GSM, UMTS
- IF Amplifier
- Wireless Data, Satellite

Parameter	Specification			Unit	Condition
	Min.	Typ.	Max.		
Small Signal Gain	15.5	17.5	19.0	dB	850MHz
		14.8		dB	1950MHz
		14.2		dB	2400MHz
Output Power at 1dB Compression		14.3		dBm	850MHz
		13.0		dBm	1950MHz
Output Third Intercept Point		28.7		dBm	850MHz
		25.7		dBm	1950MHz
Bandwidth Determined by Return Loss		4000		MHz	>9dB
Input Return Loss		14.4		dB	1950MHz
Output Return Loss		10.7		dB	1950MHz
Noise Figure		3.1		dB	1950MHz
Device Operating Voltage	2.9	3.2	3.5	V	
Device Operating Current	41	45	49	mA	
Thermal Resistance (Junction - Lead)		255		°C/W	

Test Conditions: $V_S = 8\text{ V}, I_D = 45\text{ mA Typ.}, OIP_3$ Tone Spacing = 1MHz, P_{OUT} per tone = -5dBm, $R_{BIAS} = 110\Omega, T_L = 25^\circ\text{C}, Z_S = Z_L = 50\Omega$

Absolute Maximum Ratings

Parameter	Rating	Unit
Max Device Current (I_D)	90	mA
Max Device Voltage (V_D)	5	V
Max RF Input Power	+18	dBm
Max Junction Temp (T_J)	+150	°C
Operating Temp Range (T_L)	-40 to +85	°C
Max Storage Temp	+150	°C



Caution! ESD sensitive device.

Exceeding any one or a combination of the Absolute Maximum Rating conditions may cause permanent damage to the device. Extended application of Absolute Maximum Rating conditions to the device may reduce device reliability. Specified typical performance or functional operation of the device under Absolute Maximum Rating conditions is not implied.

RoHS status based on EU Directive 2002/95/EC (at time of this document revision).

The information in this publication is believed to be accurate and reliable. However, no responsibility is assumed by RF Micro Devices, Inc. ("RFMD") for its use, nor for any infringement of patents, or other rights of third parties, resulting from its use. No license is granted by implication or otherwise under any patent or patent rights of RFMD. RFMD reserves the right to change component circuitry, recommended application circuitry and specifications at any time without prior notice.

Operation of this device beyond any one of these limits may cause permanent damage. For reliable continuous operation, the device voltage and current must not exceed the maximum operating values specified in the table on page one.

Bias Conditions should also satisfy the following expression:

$$I_D V_D < (T_J - T_L) / R_{TH, J-I}$$

Typical Performance at Key Operating Frequencies

Parameter	Unit	100 MHz	500 MHz	850 MHz	1950 MHz	2400 MHz	3500 MHz
Small Signal Gain	dB	17.7	17.6	17.5	14.8	14.2	12.5
Output Third Order Intercept Point	dBm		29.4	28.7	25.7	23.8	
Output Power at 1dB Compression	dBm		14.3	14.3	13.0	11.8	
Input Return Loss	dB	11.9	12.2	12.9	14.4	13.6	11.0
Output Return Loss	dB	10.2	11.5	13.3	10.7	9.2	9.7
Reverse Isolation	dB	20.9	21.4	21.4	20.7	20.1	18.4
Noise Figure	dB		2.8	2.7	3.1	3.6	

Test Conditions: $V_S = 8V$, $I_D = 45mA$ Typ., OIP₃ Tone Spacing = 1MHz, P_{OUT} per tone = -5dBm, R_{BIAS} = 110Ω, T_L = 25°C, Z_S = Z_L = 50Ω

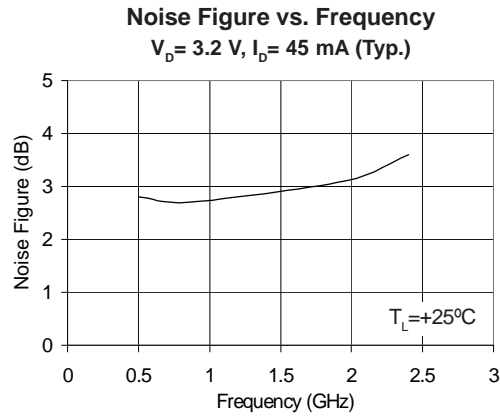
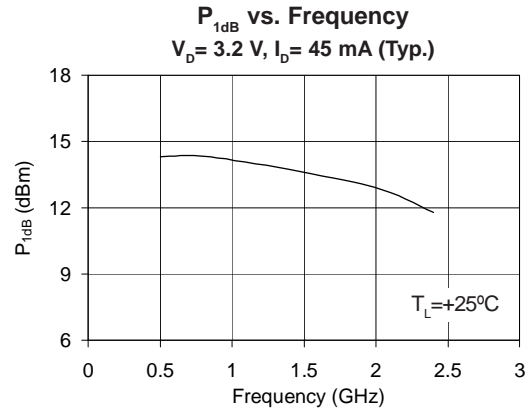
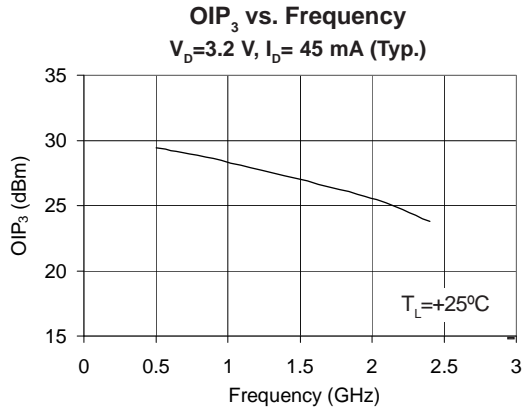

Typical RF Performance Over Temperature (Bias: $V_D = 3.2$ V, $I_D = 45$ mA (Typ.))

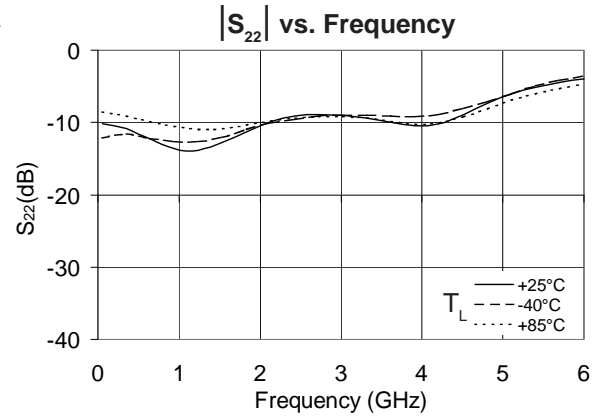
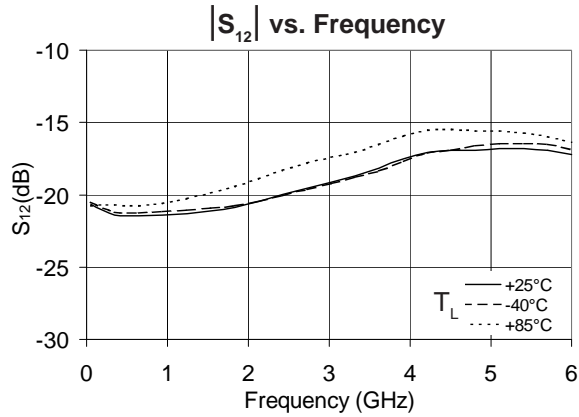
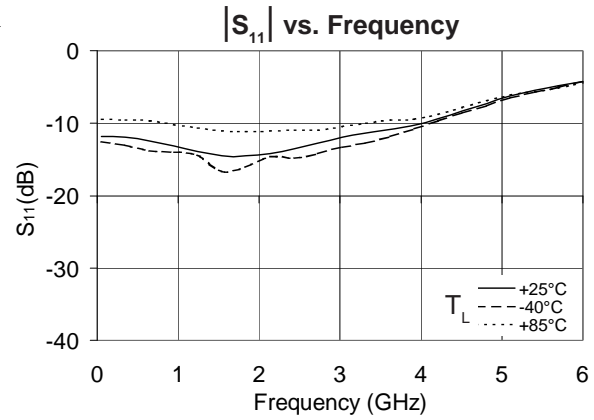
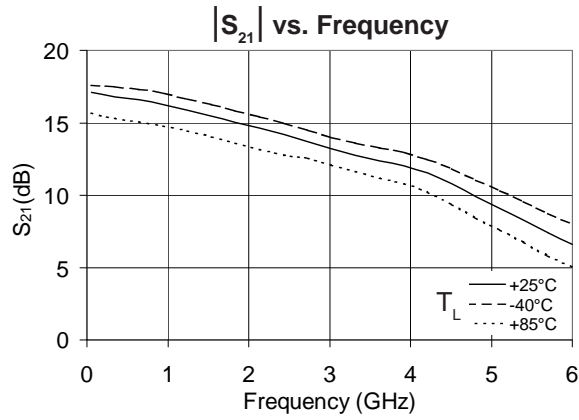

Pin	Function	Description
3	RF IN	RF input pin. This pin requires the use of an external DC-blocking capacitor chosen for the frequency of operation.
1, 2, 4, 5	GND	Connection to ground. For optimum RF performance, use via holes as close to ground leads as possible to reduce lead inductance.
6	RF OUT/BIAS	RF output and bias pin. DC voltage is present on this pin, therefore a DC-blocking capacitor is necessary for proper operation.

Suggested Pad Layout

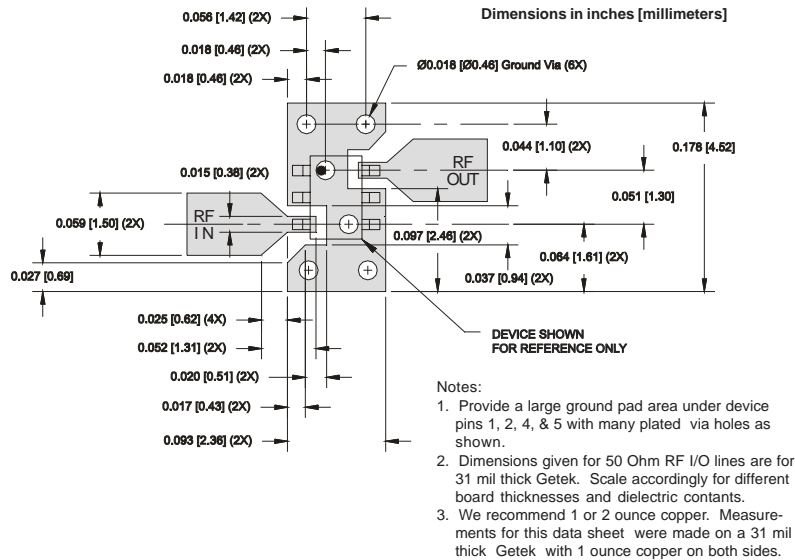

Package Drawing

Dimensions in inches (millimeters)
 Refer to drawing posted at www.rfmd.com for tolerances.

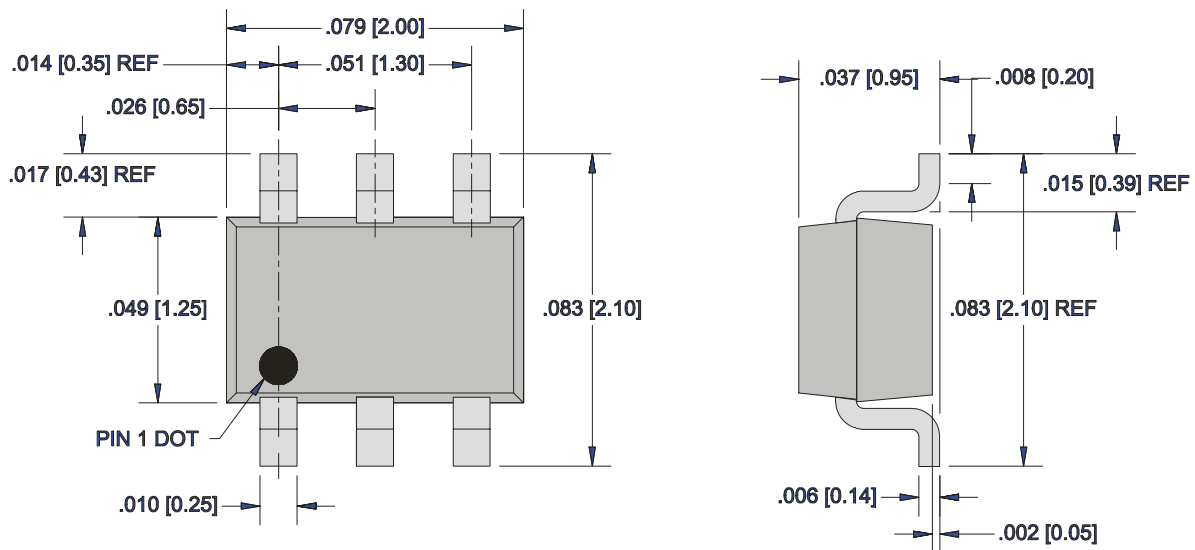

Application Schematic

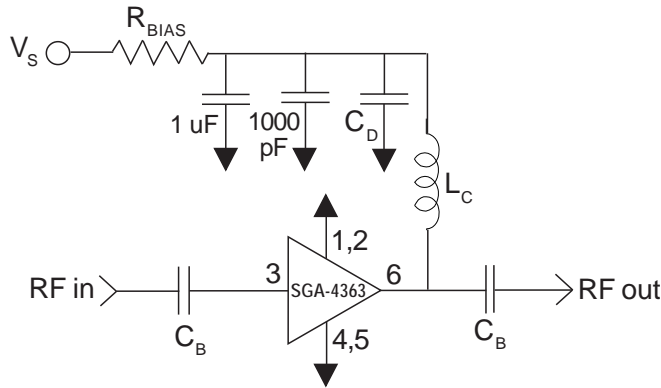

Reference Designator	Frequency (Mhz)				
	500	850	1950	2400	3500
C _B	220 pF	100 pF	68 pF	56 pF	39 pF
C _D	100 pF	68 pF	22 pF	22 pF	15 pF
L _C	68 nH	33 nH	22 nH	18 nH	15 nH

Recommended Bias Resistor Values for I _D =45mA					
$R_{BIAS} = (V_S - V_D) / I_D$					
Supply Voltage (V _S)	6 V	8 V	10 V	12 V	
R _{BIAS}	62 Ω	110 Ω	150 Ω	200 Ω	

Note: R_{BIAS} provides DC bias stability over temperature.

Evaluation Board Layout

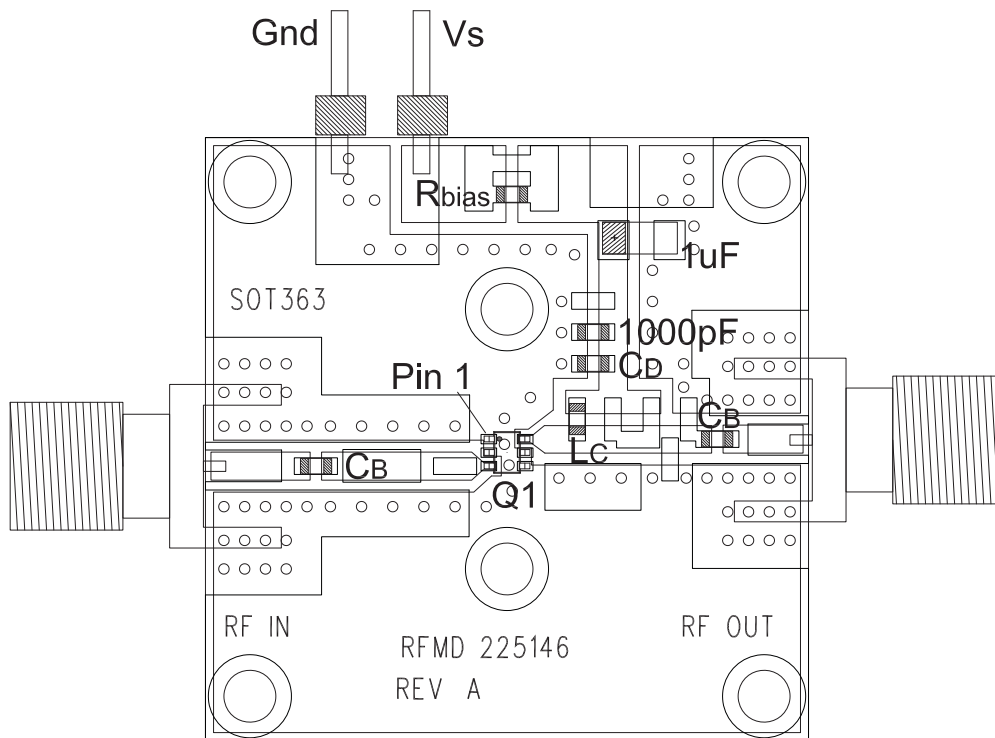

Mounting Instructions:

1. Use a large ground pad area near device pins 1, 2, 4, and 5 with many plated through-holes, as shown.
2. We recommend 1 or 2 ounces copper. Measurements for this data sheet were made on a 31mil thick FR-4 board with 1 ounce copper on both sides.

Part Identification Marking

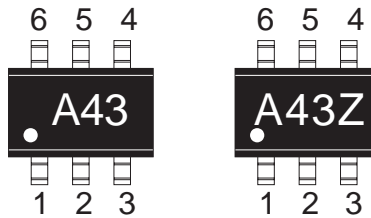

Alternate Marking with Trace Code Only

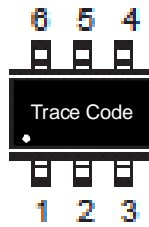

Ordering Information

Part Number	Reel Size	Devices/Reel
SGA-4363	7"	3000
SGA-4363Z	7"	3000

