

8CH HIGH-VOLTAGE SOURCE DRIVER

The TD62783AP/F/AF Series are comprised of eight source current Transistor Array.
These drivers are specifically designed for fluorescent display applications.
Applications include relay, hammer and lamp drivers.

FEATURES

- High output voltage Type-AP, AF : $V_{CC} = 50V$ MIN.
Type-F : $V_{CC} = 35V$ MIN.
- Output current (single output) $I_{OUT} = -500mA$ MIN.
- Output clamp diodes
- Single supply voltage
- Input compatible with various types of logic
- Package Type-AP : DIP-18pin
- Package Type-F, AF : SOP-18pin

TYPE	DESIGNATION
TD62783AP/F/AF	TTL, 5V CMOS
TD62784AP/F/AF	6~15V PMOS, CMOS

PIN CONNECTION (TOP VIEW)

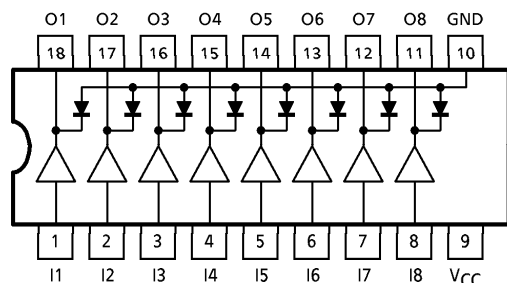

SCHEMATICS (EACH DRIVER)

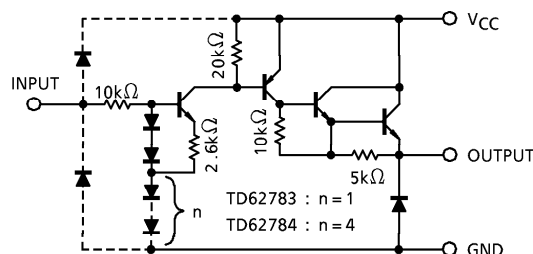

(Note) The input and output parasitic diodes cannot be used as clamp diodes.

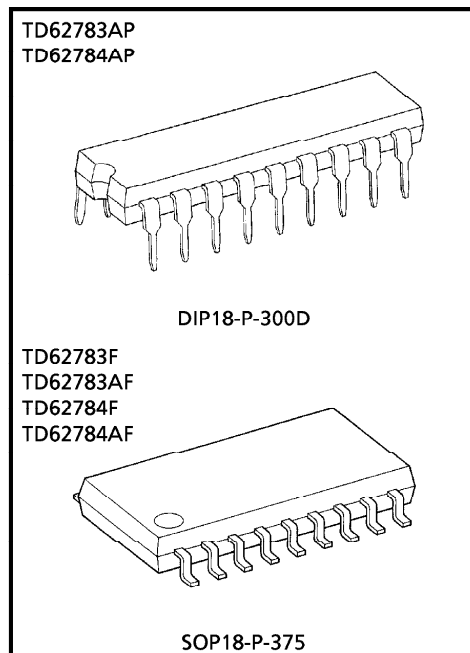

Weight DIP18-P-300D : 1.47g (Typ.)
SOP18-P-375 : 0.41g (Typ.)

© The information contained herein is presented only as a guide for the applications of our products. No responsibility is assumed by TOSHIBA CORPORATION for any infringements of intellectual property or other rights of the third parties which may result from its use. No license is granted by implication of otherwise under any intellectual property or other rights of TOSHIBA CORPORATION or others.

© These TOSHIBA products are intended for use in general commercial applications (office equipment, communication equipment, measuring equipment, domestic appliances, etc.). please make sure that you consult with us before you use these TOSHIBA products in equipment which requires extraordinarily high quality and/or reliability, and in equipment which may involve life threatening or critical application, including but not limited to such uses as atomic energy control, airplane or spaceship instrumentation, traffic signals, medical instrumentation, combustion control, all types of safety devices, etc. TOSHIBA cannot accept and hereby disclaims liability for any damage which may occur in case the TOSHIBA products are used in such equipment or applications without prior consultation with TOSHIBA.

MAXIMUM RATINGS (Ta = 25°C)

CHARACTERISTIC		SYMBOL	RATING	UNIT
Supply Voltage	AP, AF	V _{CC}	50	V
	F		35	
Output Current		I _{OUT}	- 500	mA / ch
Input Voltage		V _{IN} (Note 1)	15	V
		V _{IN} (Note 2)	30	
Clamp Diode Reverse Voltage	AP, AF	V _R	50	V
	F		35	
Clamp Diode Forward Current		I _F	500	mA
Power Dissipation	AP	P _D (Note 3)	1.47	W
	F, AF		0.96	
Operating Temperature		T _{opr}	- 40~85	°C
Storage Temperature		T _{stg}	- 55~150	°C

(Note 1) Only TD62783AP / F / AF

(Note 2) Only TD62784AP / F / AF

(Note 3) Delated above 25°C in the proportion of 11.7W/°C (AP Type), 7.7W/°C (F, AF Type).

RECOMMENDED OPERATING CONDITIONS (Ta = - 40~85°C)

CHARACTERISTIC		SYMBOL	TEST CONDITION	MIN.	TYP.	MAX.	UNIT	
Supply Voltage	AP, AF	V _{CC}	—	—	—	50	V	
	F		—	—	—	35		
Output Current		I _{OUT}	Ta = 85°C T _j = 120°C T _{pw} = 25ms	Duty = 10% 8 Circuits	—	—	- 260	mA / ch
				Duty = 50% 8 Circuits	—	—	- 59	
				Duty = 10% 8 Circuits	—	—	- 180	
				Duty = 50% 8 Circuits	—	—	- 38	
Input Voltage	TD62783AP / F / AF		V _{IN}	—	—	12	V	
	TD62784AP / F / AF			—	—	24		
Input Voltage	Output On	TD62783AP / F / AF	V _{IN} (ON)	—	2.0	5.0	V	
		TD62784AP / F / AF		—	4.5	12.0		30
	Output Off	TD62783AP / F / AF	V _{IN} (OFF)	—	0	—		0.8
		TD62784AP / F / AF		—	0	—		2.0
Clamp Diode Reverse Voltage	AP	V _R	—	—	—	50	V	
	F, AF		—	—	—	35		
Clamp Diode Forward Current		I _F	—	—	—	400	mA	
Power Dissipation	AP	P _D	—	—	—	0.52	W	
	F, AF		—	—	—	0.35		

ELECTRICAL CHARACTERISTICS (Ta = 25°C)

CHARACTERISTIC		SYMBOL	TEST CIR-CUIT	TEST CONDITION	MIN.	TYP.	MAX.	UNIT
Output Leakage Current		I _{CEX}	1	V _{CC} = V _{CC} MAX. V _{IN} = 0.4V Ta = 25°C	—	—	100	μA
Output Saturation Voltage		V _{CE} (sat)	2	V _{IN} = V _{IN} (ON), I _{OUT} = -350mA	—	—	2.0	V
				V _{IN} = V _{IN} (ON), I _{OUT} = -225mA	—	—	1.9	
				V _{IN} = V _{IN} (ON), I _{OUT} = -100mA	—	—	1.8	
Input Current	TD62783AP / F / AF	I _{IN} (ON)	3	V _{IN} = 2.4V	—	36	52	μA
	TD62784AP / F / AF			V _{IN} = 3.85V	—	180	260	
				V _{IN} = 5V	—	92	130	
				V _{IN} = 12V	—	790	1130	
Input Voltage	TD62783AP / F / AF	V _{IN} (ON)	4	V _{CE} = 2.0V	—	—	2.0	V
	TD62784AP / F / AF			I _{OUT} = -350mA	—	—	4.5	
	TD62783AP / F / AF	V _{IN} (OFF)	4	I _{OUT} = -500μA	0.8	—	—	
	TD62784AP / F / AF				2.0	—	—	
Supply Current		I _{CC} (ON)	3	V _{IN} = V _{IN} (ON), V _{CC} = 50V	—	—	2.5	mA / ch
Clamp Diode Reverse Current	AP, AF	I _R	5	V _R = 50V	—	—	50	μA
	F			V _R = 35V	—	—	50	
Clamp Diode Forward Voltage		V _F	6	I _F = 350mA	—	—	2.0	V
Turn-On Delay		t _{ON}	7	V _{CC} = V _{CC} MAX. R _L = 125Ω C _L = 15pF, R _L = 88Ω (F)	—	0.15	—	μs
Turn-Off Delay		t _{OFF}			—	1.8	—	

TEST CIRCUIT

1. I_{CEX}

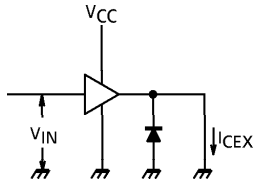

2. $V_{CE(sat)}$

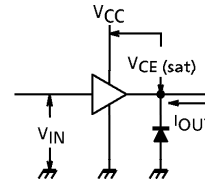

3. $I_{IN(ON)}, I_{CC}$

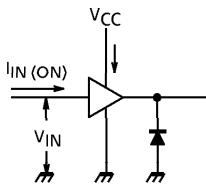

4. $V_{IN(ON)}, V_{IN(OFF)}$

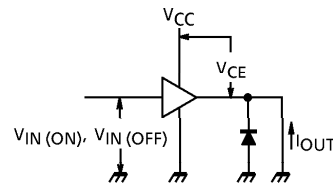

5. I_R

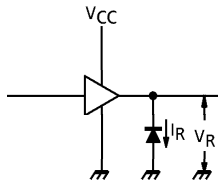

6. V_F

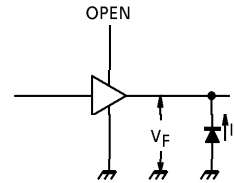

7. t_{ON}, t_{OFF}

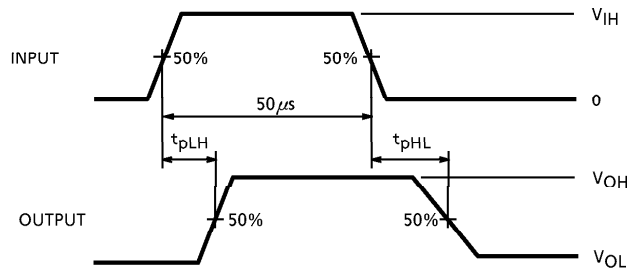
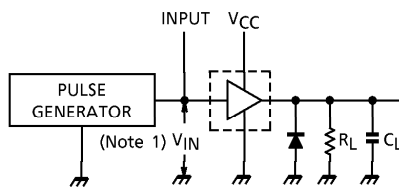

(Note 1) Pulse width $50\mu s$, duty cycle 10%
Output impedance 50Ω , $t_r \leq 5ns$, $t_f \leq 10ns$
(Note 2) C_L includes probe and jig capacitance

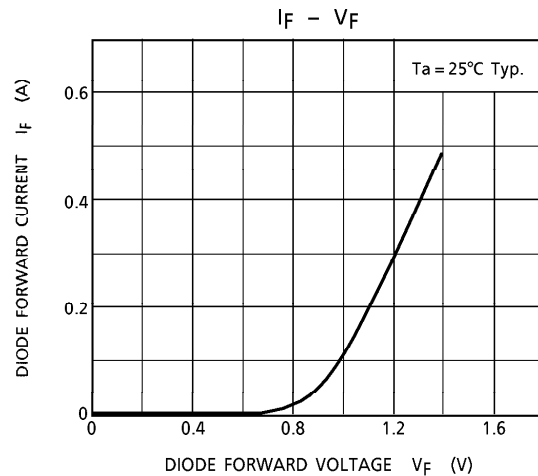
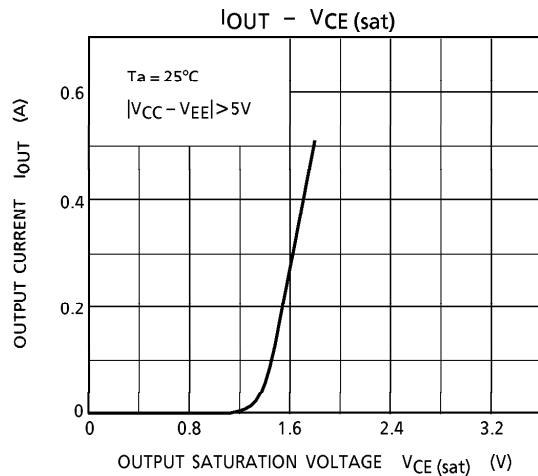
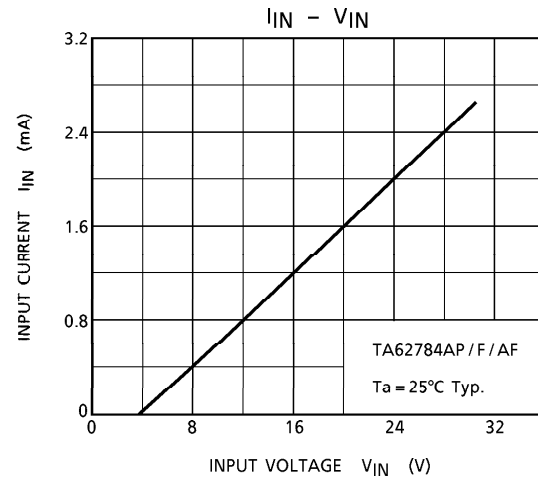
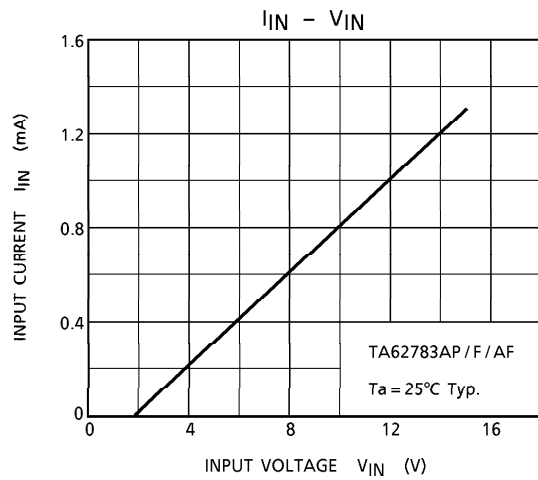
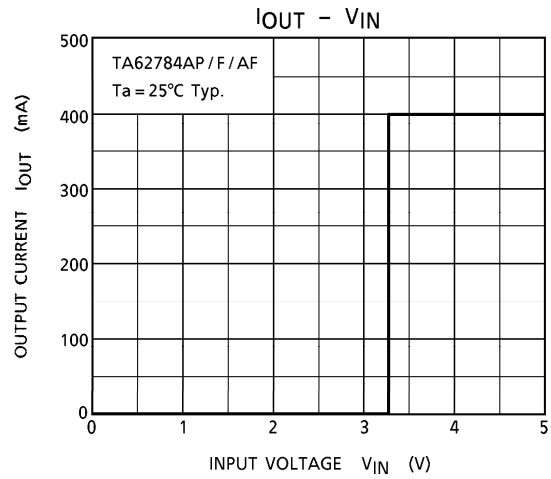
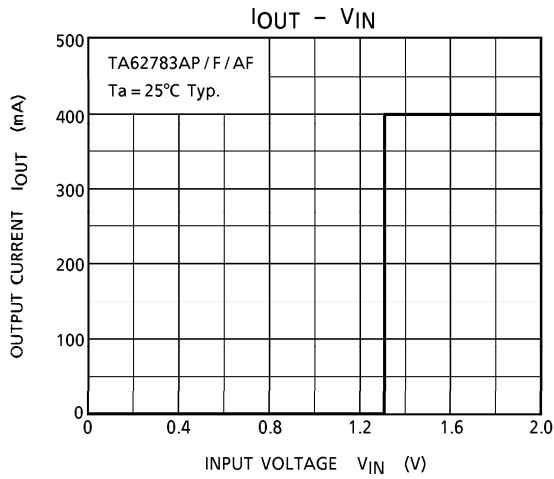

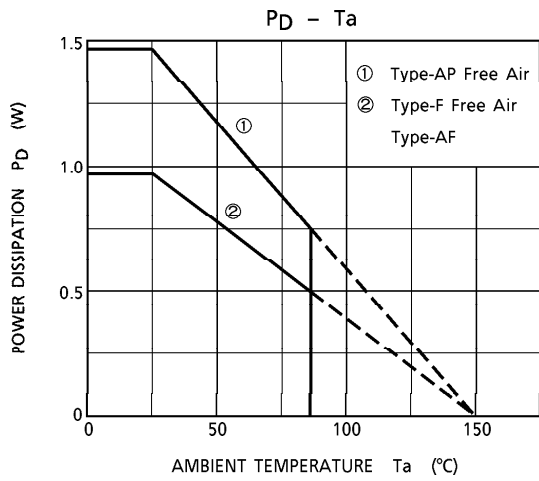

OUTLINE DRAWING
DIP18-P-300D

Unit : mm

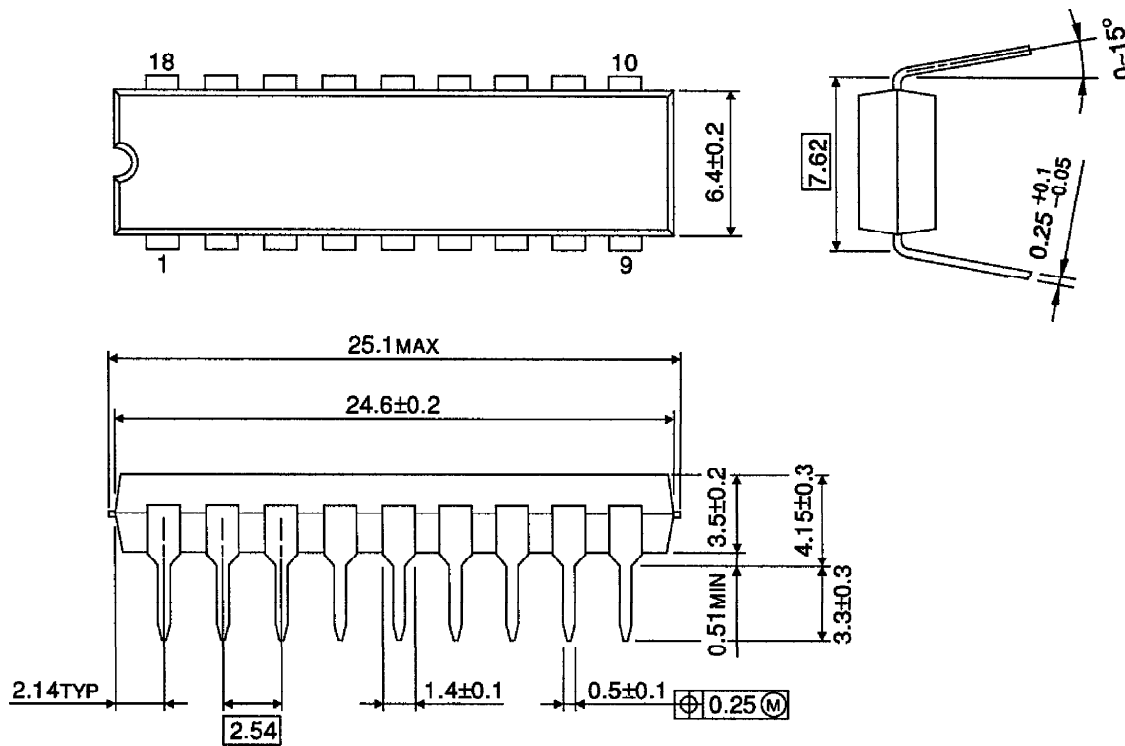

Weight : 1.47g (Typ.)

OUTLINE DRAWING
 SOP18-P-375

Unit : mm

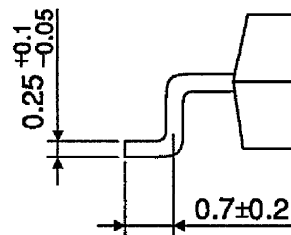
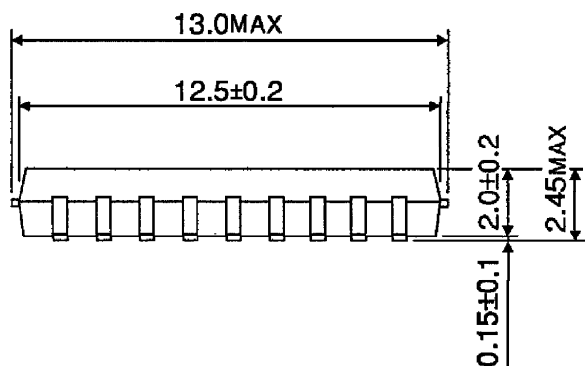
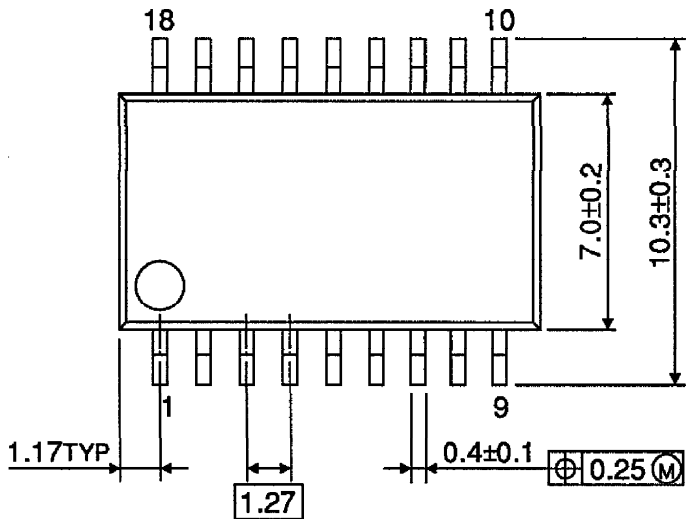

Weight : 0.41g (Typ.)