

Product Specification

SPECIFICATION FOR APPROVAL

- () Preliminary Specification
(V) Final Specification

Title	12.1" SVGA TFT LCD
-------	--------------------

BUYER	
MODEL	

SUPPLIER	LG.Philips LCD Co., Ltd.
*MODEL	LB121S03
Suffix	TD01

*When you obtain standard approval,
please use the above model name without suffix

SIGNATURE	DATE
/	_____
/	_____
/	_____

SIGNATURE	DATE
C. S. Kyoung / G.Manager	_____
REVIEWED BY	
S. D. Jung / Manager	_____
PREPARED BY	
H. Y. Park/ Project Leader	_____

Please return 1 copy for your confirmation with your signature and comments.

**Products Engineering Dept.
LG. Philips LCD Co., Ltd**

Product Specification

Contents

No	ITEM	Page
	COVER	1
	CONTENTS	2
	RECORD OF REVISIONS	3
1	GENERAL DESCRIPTION	4
2	ABSOLUTE MAXIMUM RATINGS	5
3	ELECTRICAL SPECIFICATIONS	
3-1	ELECTRICAL CHARACTREISTICS	6
3-2	INTERFACE CONNECTIONS	7
3-3	SIGNAL TIMING SPECIFICATIONS	10
3-4	SIGNAL TIMING WAVEFORMS	10
3-5	COLOR INPUT DATA REFERNECE	11
3-6	POWER SEQUENCE	12
3-7	VCC POWER DIP CONDITION	12
4	OPTICAL SFECIFICATIONS	13
5	MECHANICAL CHARACTERISTICS	17
6	RELIABLITY	20
7	INTERNATIONAL STANDARDS	
7-1	SAFETY	21
7-2	EMC	21
8	PACKING	
8-1	DESIGNATION OF LOT MARK	22
8-2	PACKING FORM	22
9	PRECAUTIONS	23

Product Specification

1. General Description

The LB121S03 is a Color Active Matrix Liquid Crystal Display with an integral Cold Cathode Fluorescent Lamp (CCFL) backlight system. The matrix employs a-Si Thin Film Transistor as the active element. It is a transmissive type display operating in the normally white mode. This TFT-LCD has 12.1 inches diagonally measured active display area with SVGA resolution(600 vertical by 800 horizontal pixel array). Each pixel is divided into Red, Green and Blue sub-pixels or dots which are arranged in vertical stripes. Gray scale or the brightness of the sub-pixel color is determined with a 6-bit gray scale signal for each dot, thus, presenting a palette of more than 262,144 colors.

The LB121S03 has been designed to apply the interface method that enables low power, high speed, low EMI.

The LB121S03 is intended to support applications where thin thickness, low power are critical factors and graphic displays are important. In combination with the vertical arrangement of the sub-pixels, the LB121S03 characteristics provide an excellent flat display for office automation products such as Industrial or etc.

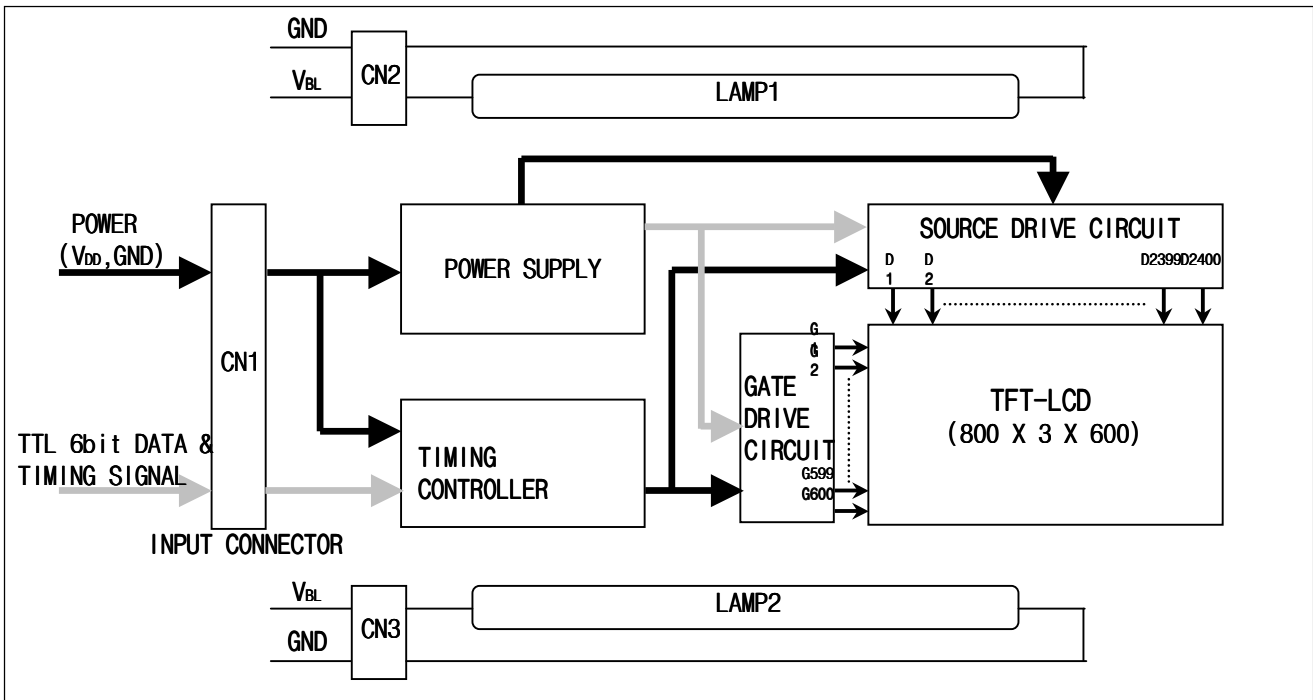

General Features

Active Screen Size	12.1 inches(30.75cm) diagonal
Outline Dimension	280(H) × 218(V) × 11(D) mm
Pixel Pitch	0.3075 mm × 0.3075 mm
Pixel Format	800 horiz. By 600 vert. Pixels RGB strip arrangement
Interface	TTL , 6bit
Color Depth	262,144 colors
Luminance, White	400 cd/m ² (Typ.)
Power Consumption	6.7 Watt(Typ.)
Weight	670.4 g (Max.)
Display Operating Mode	Transmissive mode, normally white
Surface Treatment	Hard coating(3H) Anti-glare treatment of the polarizer

Product Specification

2. Absolute Maximum Ratings

The following are maximum values which, if exceeded, may cause faulty operation or damage to the unit.

Table 1. ABSOLUTE MAXIMUM RATINGS

Parameter	Symbol	Values		Units	Notes
		Min	Max		
Power Input Voltage	VCC	-0.3	$V_{DD}+0.3$	Vdc	at $25 \pm 5^{\circ}\text{C}$
Operating Temperature	TOP	0	70	$^{\circ}\text{C}$	1
Storage Temperature	TST	-30	80	$^{\circ}\text{C}$	1
Operating Ambient Humidity	HOP	10	90	%RH	1
Storage Humidity	HST	10	90	%RH	1

Note : 1. Temperature and relative humidity range are shown in the figure below.
 Wet bulb temperature should be 60°C Max, and no condensation of water.

Product Specification

3. Electrical Specifications

3-1. Electrical Characteristics

The LB121S03 requires two power inputs. One is employed to power the LCD electronics and to drive the TFT array and liquid crystal. The second input which powers the CCFL, is typically generated by an inverter. The inverter is an external unit to the LCD.

Table 2. ELECTRICAL CHARACTERISTICS

Parameter	Symbol	Values			Unit	Notes
		Min	Typ	Max		
MODULE :						
Power Supply Input Voltage	VCC	3.0	3.3	3.6	Vdc	
Power Supply Input Current	I _{CC}	-	185	245	mA	1
Power Consumption	P _c	-	0.6	1.0	Watt	1
LAMP :						
Operating Voltage	V _{BL}	470 (8.0 mA _{RMS})	510 (6.0 mA _{RMS})	570 (3.0 mA _{RMS})	V _{RMS}	2
Operating Current	I _{BL}	3.0	6.0	8.0	mA _{RMS}	3
Established Starting Voltage	V _s					4
	at 25 °C	-	-	800	V _{RMS}	
	at 0 °C	-	-	1,000	V _{RMS}	
Operating Frequency	f _{BL}	40	60	80	kHz	5
Discharge Stabilization Time	T _s	-	-	3	Min	6
Power Consumption	P _{BL}	-	6.12	6.73	Watt	7
Life Time		50,000	-	-	Hrs	8

Note)

The design of the inverter must have specifications for the lamp in LCD Assembly. The performance of the Lamp in LCM, for example life time or brightness, is extremely influenced by the characteristics of the DC-AC inverter. So all the parameters of an inverter should be carefully designed so as not to produce too much leakage current from high-voltage output of the inverter. When you design or order the inverter, please make sure unwanted lighting caused by the mismatch of the lamp and the inverter(no lighting, flicker, etc) never occurs. When you confirm it, the LCD Assembly should be operated in the same condition as installed in your instrument.

1. VCC=3.3V, 25°C, f_v (frame frequency) = 60Hz condition, whereas Mosaic pattern(Typ), full black pattern(Max) is displayed.
2. The variance of the voltage is ± 10%.
3. The typical operating current is for the typical surface luminance (L_{WH}) in optical characteristics.
4. The voltage above VS should be applied to the lamps for more than 1 second for start-up. Otherwise, the lamps may not be turned on. The used lamp current is the lamp typical current.

Product Specification

5. The output of the inverter must have symmetrical(negative and positive) voltage waveform and symmetrical current waveform.(Unsymmetrical ratio is less than 10%) Please do not use the inverter which has unsymmetrical voltage and unsymmetrical current and spike wave.
Lamp frequency may produce interference with horizontal synchronous frequency and as a result this may cause beat on the display. Therefore lamp frequency shall be as away possible from the horizontal synchronous frequency and from its harmonics in order to prevent interference.
 6. Let's define the brightness of the lamp after being lighted for 5 minutes as 100%.
 T_s is the time required for the brightness of the center of the lamp to be not less than 95%.
 7. The lamp power consumption shown above does not include loss of external inverter.
The used lamp current is the lamp typical current. (2 Lamp)
 8. The life time is determined as the time at which brightness of the lamp is 50% compared to that of initial value at the typical lamp current on condition of continuous operating at $25 \pm 2^\circ\text{C}$.
- * Requirements for a system inverter design, which is intended to have a better display performance, a better power efficiency and a more reliable lamp, are following. It shall help increase the lamp lifetime and reduce leakage current.
- a. The asymmetry rate of the inverter waveform should be less than 10%.
 - b. The distortion rate of the waveform should be within $\sqrt{2} \pm 10\%$.
- * Inverter output waveform had better be more similar to ideal sine wave.

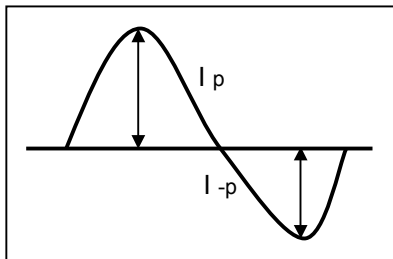

* Asymmetry rate:

$$\frac{|I_p - I_{-p}|}{I_{rms}} * 100\%$$

* Distortion rate

$$I_p \text{ (or } I_{-p}) / I_{rms}$$

- * Do not attach a conducting tape to lamp connecting wire.
If the lamp wire attach to a conducting tape, TFT-LCD Module has a low luminance and the inverter has abnormal action. Because leakage current is occurred between lamp wire and conducting tape.

3-2. Interface Connections

This LCD employs Three interface connections, a 41 pin connector is used for the module electronics interface and the other connectors are used for the integral backlight system.
The electronics interface connector is a model DF9B-41P-1V manufactured by Hirose or equivalent.

Table 3. MODULE CONNECTOR PIN CONFIGURATION (CN1)

Product Specification

Pin	Symbol	Description	Notes
1	Vss	Ground	See Note 1
2	CLK	Main Clock	
3	Vss	Ground	See Note 1
4	Hsync	Horizontal sync.	
5	Vsync	Vertical sync.	
6	Vss	Ground	See Note 1
7	Vss	Ground	See Note 1
8	Vss	Ground	See Note 1
9	R0	Red Data	Red data least significant bit (LSB)
10	R1	Red Data	
11	R2	Red Data	
12	Vss	Ground	See Note 1
13	R3	Red Data	
14	R4	Red Data	
15	R5	Red Data	Red data most significant bit (MSB)
16	Vss	Ground	See Note 1
17	Vss	Ground	See Note 1
18	Vss	Ground	See Note 1
19	G0	Green Data	Green data least significant bit (LSB)
20	G1	Green Data	
21	G2	Green Data	
22	Vss	Ground	See Note 1
23	G3	Green Data	
24	G4	Green Data	
25	G5	Green Data	Green data most significant bit (MSB)
26	Vss	Ground	See Note 1
27	Vss	Ground	See Note 1
28	Vss	Ground	See Note 1
29	B0	Blue Data	Blue data least significant bit (LSB)
30	B1	Blue Data	
31	B2	Blue Data	
32	Vss	Ground	See Note 1
33	B3	Blue Data	
34	B4	Blue Data	
35	B5	Blue Data	Blue data most significant bit (MSB)
36	Vss	Ground	See Note 1
37	DE	Data Enable signal	
38	L_R	Horizontal display mode Select signal	See Note 3
39	V _{DD}	Power Input (3.3V)	See Note 2
40	V _{DD}	Power Input (3.3V)	See Note 2
41	U-D	Vertical display mode select signal	See Note 4

Product Specification

- Notes : 1. All GND (Ground) Pins Should be connected together and the LCD's metal frame.
2. All V_{DD} (Power Input) Pins should be connected together.

Notes : 3. Horizontal Display Mode.

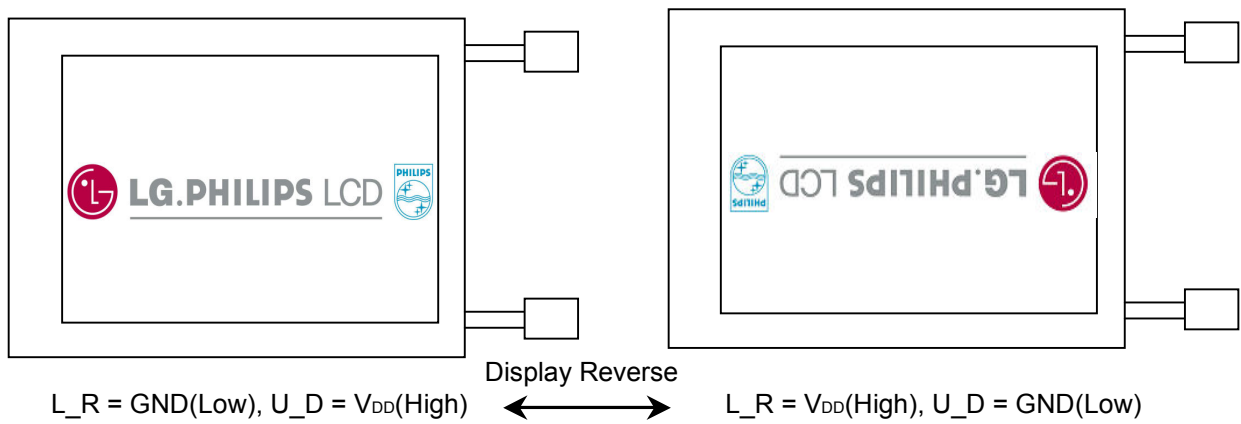

The backlight interface connector is a model BHR-03VS-1, manufactured by JST. The mating connector part number is SM02B(8.0)B-BHS-1-TB or equivalent.

Table 4. BACK LIGHT CONNECTOR PIN CONFIGURATION (CN2, CN3)

Pin	Symbol	Description	Notes
1	HV	High Voltage (Pink Color)	-
2	NC	-	-
3	LV	Low Voltage (White Color)	-

Product Specification

3-3. Signal Timing Specifications

This is the signal timing required at the input of the User connector. All of the interface signal timing should be satisfied with the following specifications.

※ If Customer supply incorrect Signal/Power, LPL cannot guarantee the Quality of LCM.

Table 5. TIMING TABLE

[60Hz]

ITEM	Symbol	Min	Typ	Max	Unit	Note
DCLK	Frequency	f _{CLK}	37.0	38.5	40.0	MHz
Hsync	Period	t _{HP}	990	1024	1100	t _{CLK}
	Width	t _{WH}	12	64	120	
Vsync	Period	t _{VP}	608	625	730	t _{HP}
	Width	t _{WV}	2	6	24	
Data Enable	Horizontal back porch	t _{HBP}	30	88	120	t _{CLK}
	Horizontal front porch	t _{HFP}	30	72	80	
	Vertical back porch	t _{VBP}	5	15	22	t _{HP}
	Vertical front porch	t _{VFP}	3	4	5	

3-4. Signal Timing Waveforms

Condition : VCC = 3.3V

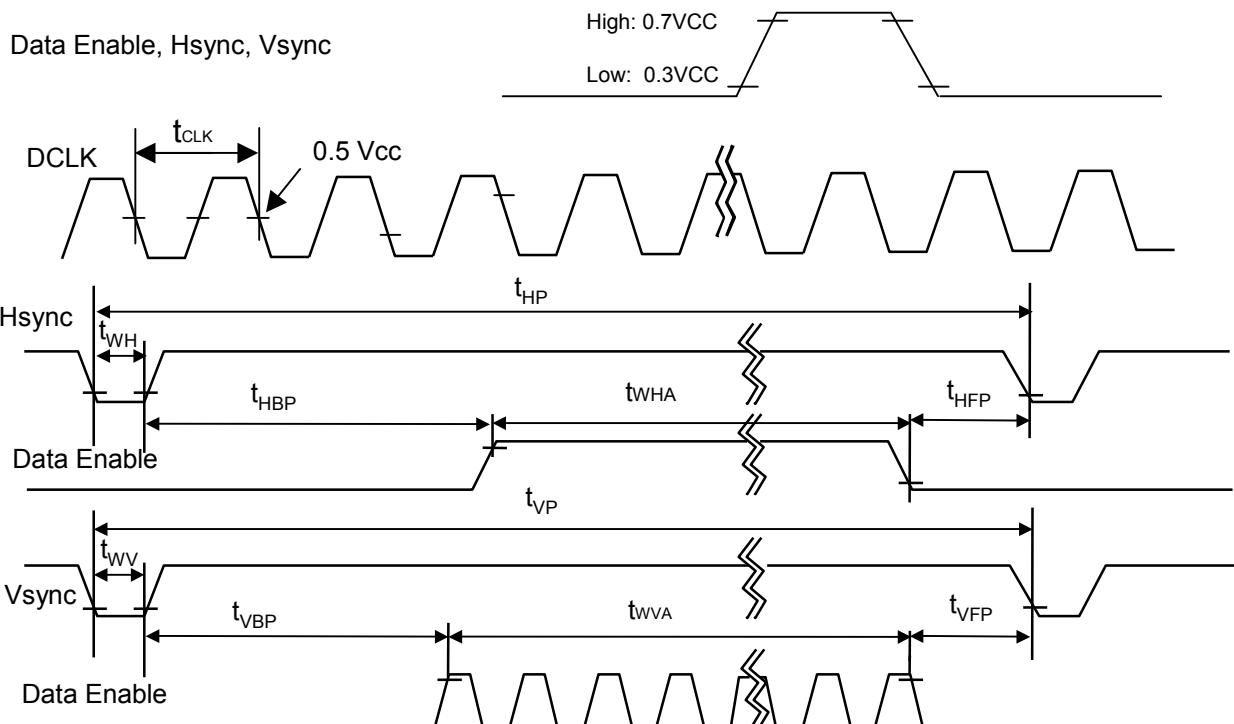

Product Specification

3-5. Color Input Data Reference

The brightness of each primary color (red, green and blue) is based on the 6-bit gray scale data input for the color ; the higher the binary input, the brighter the color. The table below provides a reference for color versus data input.

Table 6. COLOR DATA REFERENCE

Color		Input Color Data																					
		RED						GREEN						BLUE									
		MSB						LSB		MSB						LSB		MSB					
R 5	R 4	R 3	R 2	R 1	R 0	G 5	G 4	G 3	G 2	G 1	G 0	B 5	B 4	B 3	B 2	B 1	B 0						
Basic Color	Black	0	0	0	0	0	0	0	0	0	0	0	0	0	0	0	0	0	0				
	Red	1	1	1	1	1	1	0	0	0	0	0	0	0	0	0	0	0	0				
	Green	0	0	0	0	0	0	1	1	1	1	1	1	0	0	0	0	0	0				
	Blue	0	0	0	0	0	0	0	0	0	0	0	0	1	1	1	1	1	1				
	Cyan	0	0	0	0	0	0	1	1	1	1	1	1	1	1	1	1	1	1				
	Magenta	1	1	1	1	1	1	0	0	0	0	0	0	1	1	1	1	1	1				
	Yellow	1	1	1	1	1	1	1	1	1	1	1	1	0	0	0	0	0	0				
	White	1	1	1	1	1	1	1	1	1	1	1	1	1	1	1	1	1	1				
RED	RED (00)	0	0	0	0	0	0	0	0	0	0	0	0	0	0	0	0	0	0				
	RED (01)	0	0	0	0	0	1	0	0	0	0	0	0	0	0	0	0	0	0				
									
	RED (62)	1	1	1	1	1	0	0	0	0	0	0	0	0	0	0	0	0	0				
	RED (63)	1	1	1	1	1	1	0	0	0	0	0	0	0	0	0	0	0	0				
GREEN	GREEN (00)	0	0	0	0	0	0	0	0	0	0	0	0	0	0	0	0	0	0				
	GREEN (01)	0	0	0	0	0	0	0	0	0	0	0	1	0	0	0	0	0	0				
									
	GREEN (62)	0	0	0	0	0	0	1	1	1	1	1	0	0	0	0	0	0	0				
	GREEN (63)	0	0	0	0	0	0	1	1	1	1	1	1	0	0	0	0	0	0				
BLUE	BLUE (00)	0	0	0	0	0	0	0	0	0	0	0	0	0	0	0	0	0	0				
	BLUE (01)	0	0	0	0	0	0	0	0	0	0	0	0	0	0	0	0	0	1				
									
	BLUE (62)	0	0	0	0	0	0	0	0	0	0	0	0	1	1	1	1	1	0				
	BLUE (63)	0	0	0	0	0	0	0	0	0	0	0	0	1	1	1	1	1	1				

Product Specification

3-6. Power Sequence

Power supply for LCD (VCC)

Interface Signal (Tx)

Power for Lamp

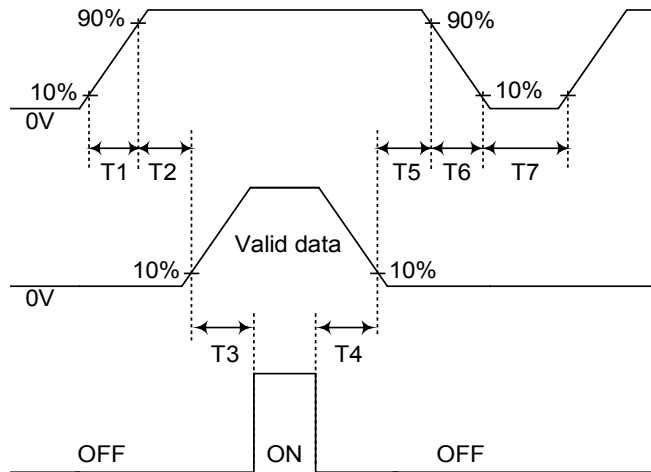

Table 7. POWER SEQUENCE TABLE

Parameter	Value			Units
	Min.	Typ.	Max.	
T ₁	-	-	10	(ms)
T ₂	0	-	50	(ms)
T ₃	200	-	-	(ms)
T ₄	200	-	-	(ms)
T ₅	0	-	50	(ms)
T ₆	-	-	10	(ms)
T ₇	2	-	-	(s)

Note)

1. Please avoid floating state of interface signal at invalid period.
2. When the interface signal is invalid, be sure to pull down the power supply for LCD VCC to 0V.
3. Lamp power must be turn on after power supply for LCD and interface signal are valid.

3.7 Vcc Power Dip Condition

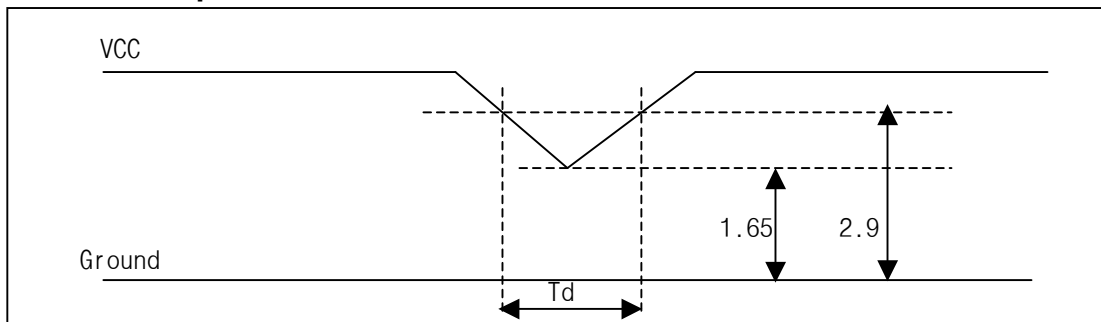

3.7.1 Dip Condition

$1.65 \leq V_{cc} \leq 2.9, t_d \leq 20ms$

3.7.2 Vcc < 1.65V

Vcc-dip Conditions should also follow the Power on/off condition for supply voltage

Product Specification

4. Optical Specification

Optical characteristics are determined after the unit has been 'ON' and stable for approximately 30 minutes in a dark environment at 25°C. The values specified are at an approximate distance 50cm from the LCD surface at a viewing angle of Φ and Θ equal to 0°.

FIG. 1 presents additional information concerning the measurement equipment and method.

FIG. 1 Optical Characteristic Measurement Equipment and Method

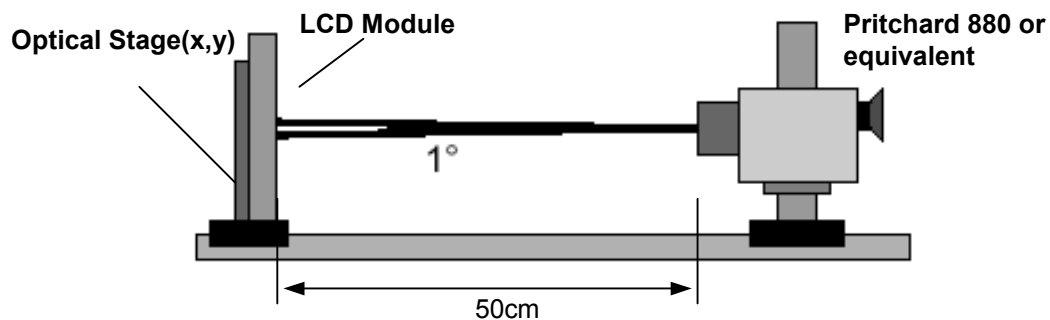

Table 8. OPTICAL CHARACTERISTICS

Ta=25°C, VCC=3.3V, fv=60Hz, Dclk= 38.5MHz, VIN=3.3V, IL=6.0mA

Parameter	Symbol	Values			Units	Notes
		Min	Typ	MAX		
Contrast Ratio	CR	350	500	-		1
Surface Luminance, white	L _{WH}	320	400	-	cd/m ²	2
Luminance Variation	δ_{WHITE}	-	1.25	1.45		3
Response Time						4
Rise Time	T _R	-	10	20	ms	
Decay Time	T _D	-	20	30	ms	
Color Coordinates						
WHITE	WX	0.310	0.340	0.370		
	WY	0.316	0.346	0.376		
Viewing Angle						5
x axis, right($\Phi=0^\circ$)	Θ_r	60	65	-	degree	
x axis, left ($\Phi=180^\circ$)	Θ_l	60	65	-	degree	
y axis, up ($\Phi=90^\circ$)	Θ_u	45	50	-	degree	
y axis, down ($\Phi=270^\circ$)	Θ_d	55	60	-	degree	

Product Specification

Note)

1. Contrast Ratio(CR) is defined mathematically as

$$\text{Contrast Ratio} = \frac{\text{Surface Luminance with all white pixels}}{\text{Surface Luminance with all black pixels}}$$

2. Surface luminance is the center point across the LCD surface 50cm from the surface with all pixels displaying white. For more information see FIG 1.

3. The variation in surface luminance , The Panel total variation (δ_{WHITE}) is determined by measuring L_N at each test position 1 through 5, and then dividing the maximum L_N of 5 points luminance by minimum L_N of 5 points luminance. For more information see FIG 2.

$$\delta_{\text{WHITE}} = \text{Maximum}(L_1, L_2, \dots L_5) / \text{Minimum}(L_1, L_2, \dots L_5)$$

4. Response time is the time required for the display to transition from white to black (rise time, Tr_R) and from black to white(Decay Time, Tr_D). For additional information see FIG 3.

5. Viewing angle is the angle at which the contrast ratio is greater than 10. The angles are determined for the horizontal or x axis and the vertical or y axis with respect to the z axis which is normal to the LCD surface. For more information see FIG 4.

6. Gray scale specification

* $f_V=60\text{Hz}$

Gray Level	Luminance [%] (Typ)
L0	0.2
L7	0.8
L15	4.0
L23	10.5
L31	19.5
L39	33.0
L47	52.0
L55	75.0
L63	100

Product Specification

FIG. 2 Luminance

<measuring point for surface luminance & measuring point for luminance variation>

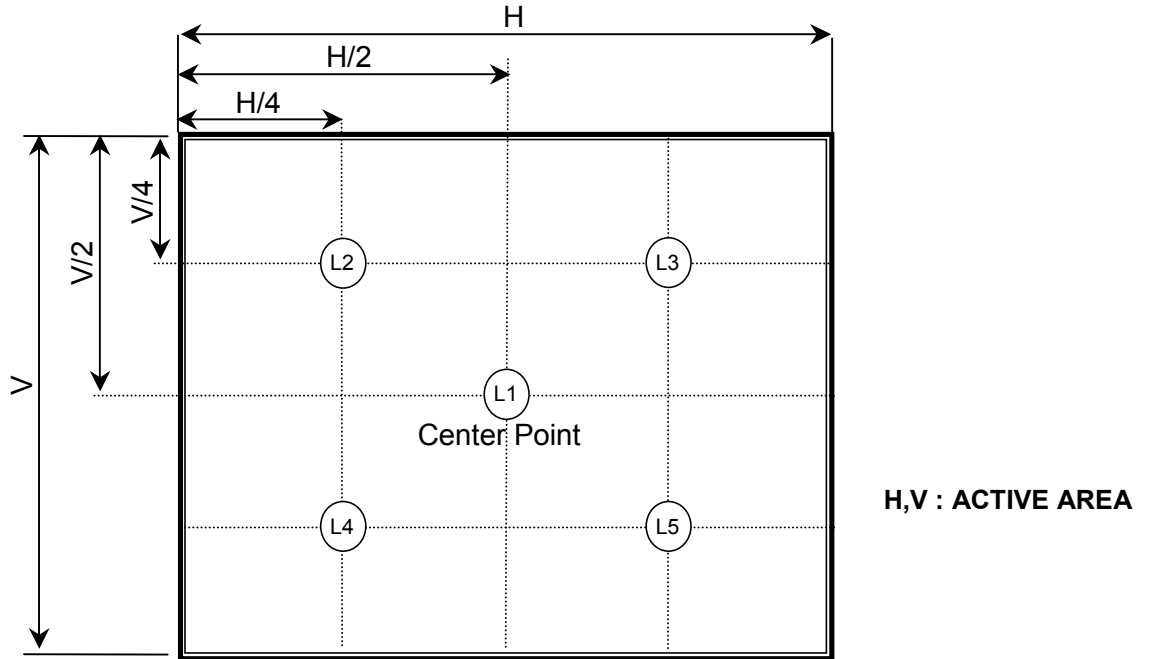
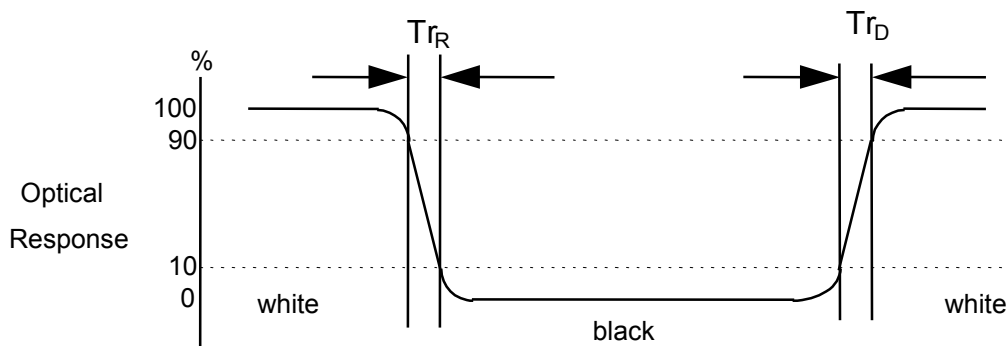

FIG. 3 Response Time

The response time is defined as the following figure and shall be measured by switching the input signal for “black” and “white”.



Product Specification

FIG. 4 Viewing angle

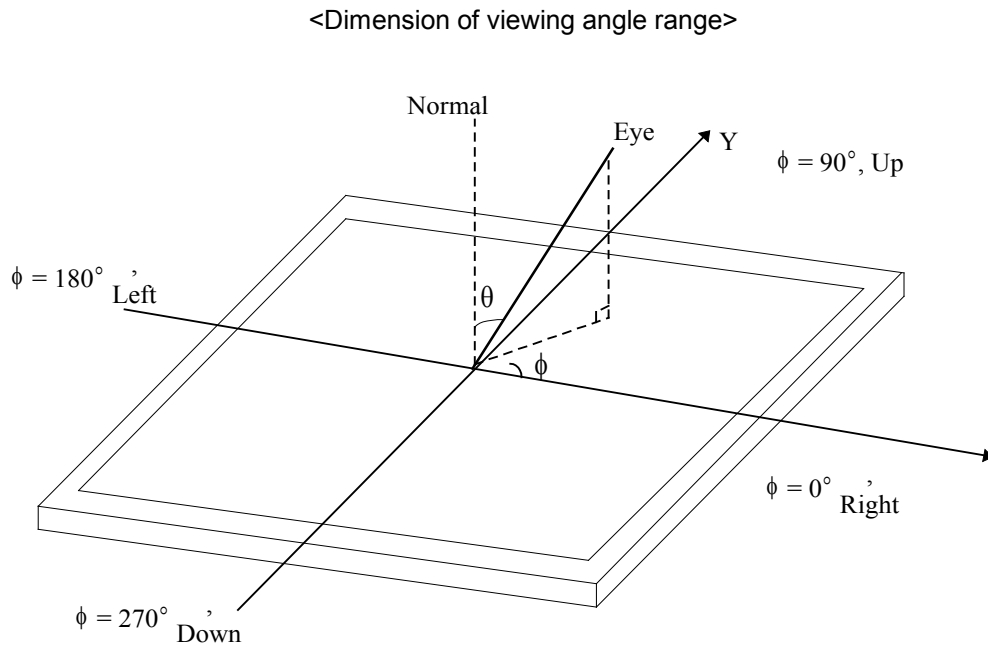

5. Mechanical Characteristics

The contents provide general mechanical characteristics for the model LB121S03. In addition the figures in the next page are detailed mechanical drawing of the LCD.

Table 9. MECHANICAL SPECIFICATION

PARAMETER	SPECIFICATION	
Outline Dimension	Horizontal	280.0 ± 0.5mm
	Vertical	218.0 ± 0.5mm
	Depth	Typ : 11.0mm
Active Display Area	Horizontal	246.0 mm
	Vertical	184.5 mm
Weight	670.4g (Max.)	
Surface Treatment	Anti-glare treatment	

Product Specification

<FRONT VIEW>

Note) Unit:[mm], General tolerance: $\pm 0.5\text{mm}$

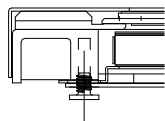
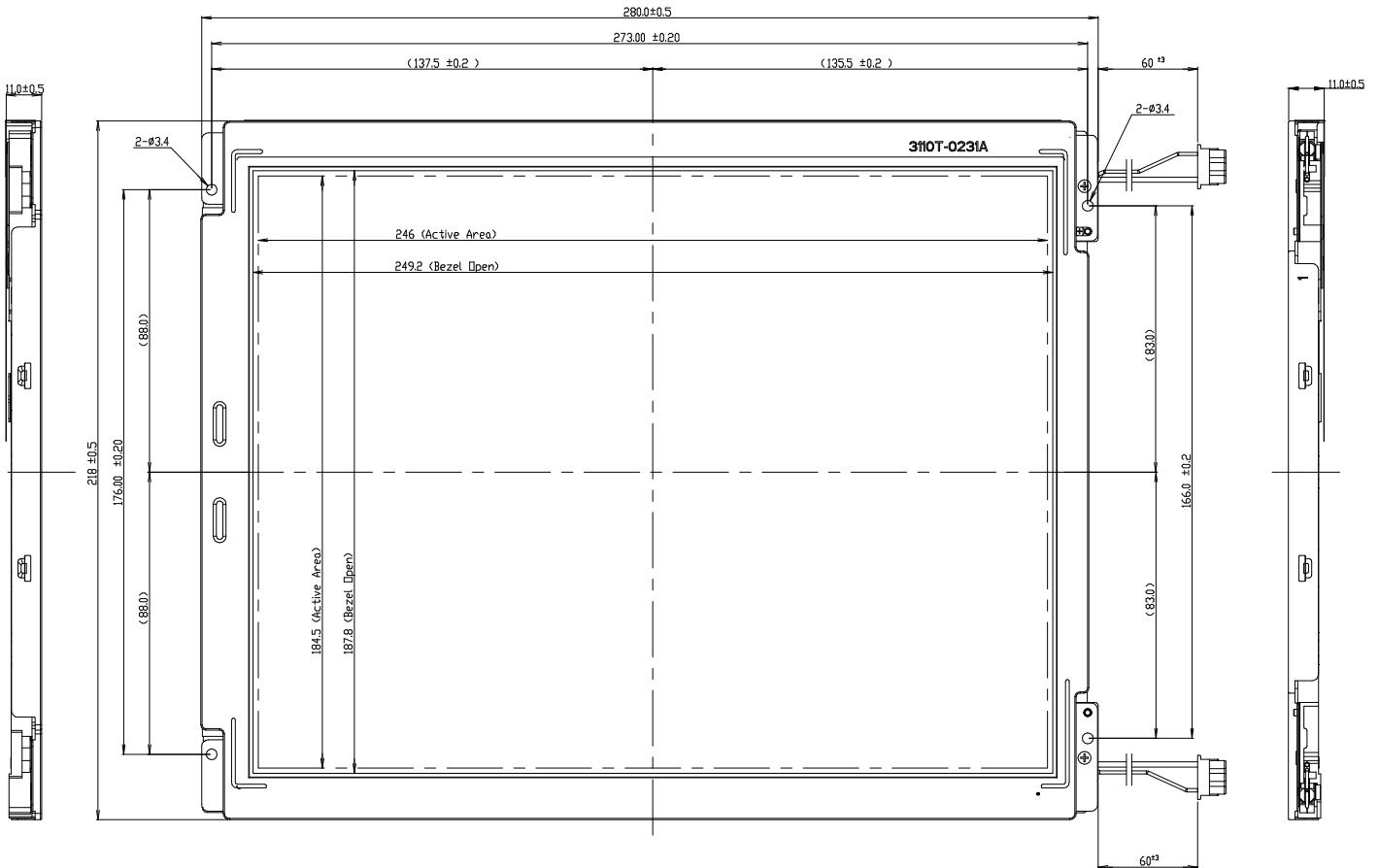

SEC-D(S/2:1)
 Screw Torque
 Max 2.5kgf.cm

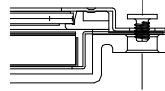

SEC-C(S/2:1)
 Screw Torque
 Max 3kgf.cm

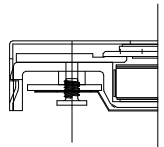

SEC-E(S/2:1)
 Screw Torque
 Max 2.5kgf.cm

Product Specification

<REAR VIEW>

Note) Unit:[mm], General tolerance: $\pm 0.5\text{mm}$

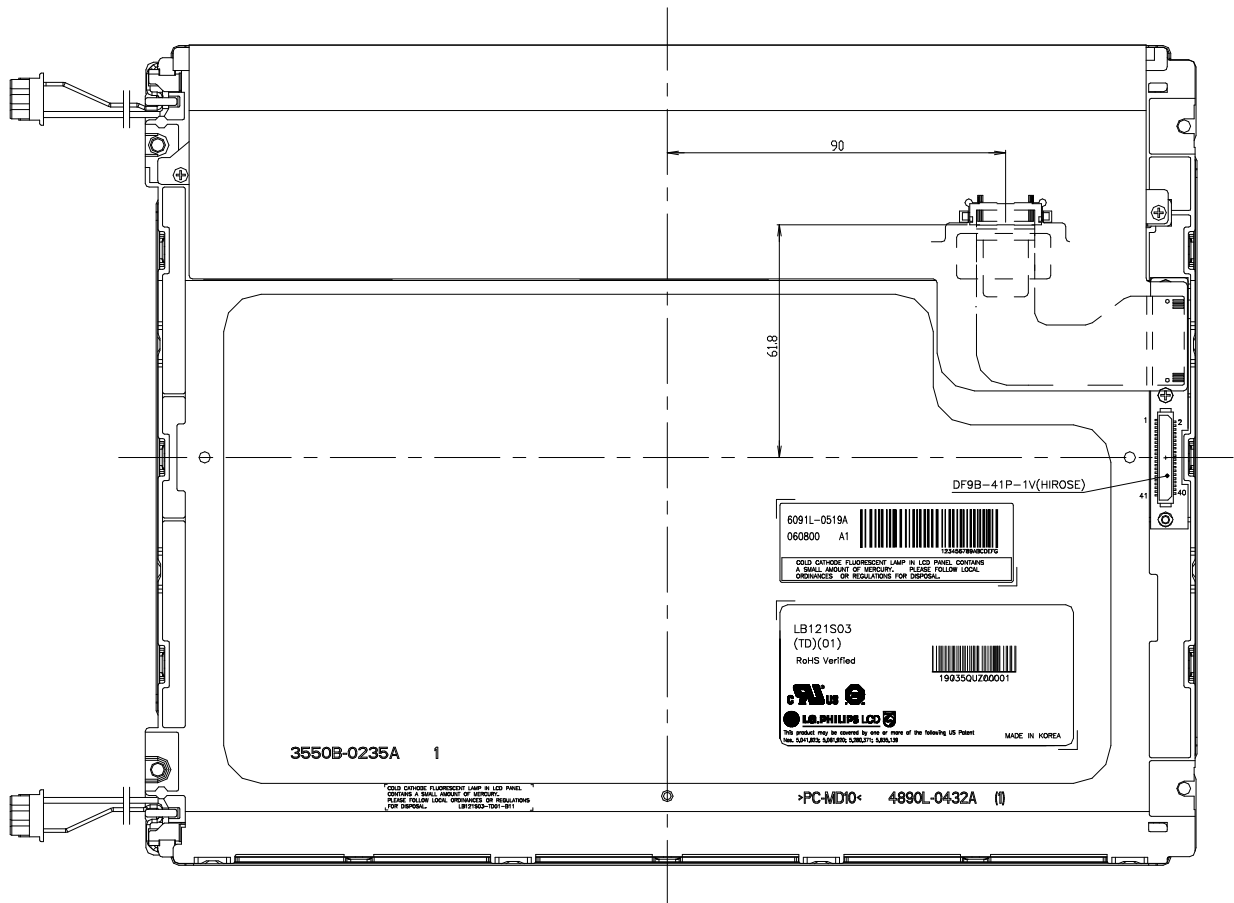

Product Specification

6. Reliability

Environment test condition

Table 10. REALIABILITY CONDITIONS

No.	Test Item	Conditions
1	High temperature storage test	Ta= 80°C, 240h
2	Low temperature storage test	Ta= -30°C, 240h
3	High temperature operation test	Ta= 70°C, 240h
4	Low temperature operation test	Ta= 0°C, 240h
5	Vibration test (non-operating)	Random, 10 ~ 300Hz, 1Grms,3 axis, 30min/axis
6	Shock test (non-operating)	Half sine wave, 120G, 2ms one shock of each six faces(I.e. run 180G 6ms for all six faces)
7	Altitude operating storage / shipment	0 ~ 10,000 feet (3,048m) 24Hr 0 ~ 40,000 feet (12,192m) 24Hr

{ Result Evaluation Criteria }

1. Evaluation should be tested after storage at room temperature for 24 hours.
2. There should be no change which might affect the practical display function when the display test quality test is conducted under normal operating condition.

7. International Standards

7-1. Safety

- a) UL 1950 Third Edition, Underwriters Laboratories, Inc. Jan. 28, 1995.
Standard for Safety of Information Technology Equipment Including Electrical Business Equipment.
- b) CAN/CSA C22.2 No. 950-95 Third Edition, Canadian Standards Association, Jan. 28, 1995.
Standard for Safety of Information Technology Equipment Including Electrical Business Equipment.
- c) EN 60950 : 1992+A1: 1993+A2: 1993+A3: 1995+A4: 1997+A11: 1997
IEC 950 : 1991+A1: 1992+A2: 1993+A3: 1995+A4: 1996
European Committee for Electrotechnical Standardization(CENELEC)
EUROPEAN STANDARD for Safety of Information Technology Equipment Including Electrical Business
Equipment.

7-2. EMC

- a) ANSI C63.4 "Methods of Measurement of Radio-Noise Emissions from Low-Voltage Electrical and Electrical Equipment in the Range of 9kHz to 40GHz. "American National Standards Institute(ANSI), 1992
- b) C.I.S.P.R "Limits and Methods of Measurement of Radio Interface Characteristics of Information Technology Equipment." International Special Committee on Radio Interference.
- c) EN 55022 "Limits and Methods of Measurement of Radio Interface Characteristics of Information Technology Equipment." European Committee for Electrotechnical Standardization.(CENELEC), 1998

Product Specification

8. Packing

8-1. Designation of Lot Mark

a) Lot Mark

A	B	C	D	E	F	G	H	I	J	K	L	M
---	---	---	---	---	---	---	---	---	---	---	---	---

A,B,C : SIZE(INCH)
E : MONTH

D : YEAR
F ~ M : SERIAL NO.

Note

1. YEAR

Year	2001	2002	2003	2004	2005	2006	2007	2008	2009	2010
Mark	1	2	3	4	5	6	7	8	9	0

2. MONTH

Month	Jan	Feb	Mar	Apr	May	Jun	Jul	Aug	Sep	Oct	Nov	Dec
Mark	1	2	3	4	5	6	7	8	9	A	B	C

b) Location of Lot Mark

Serial No. is printed on the label. The label is attached to the backside of the LCD module.
This is subject to change without prior notice.

8-2. Packing Form

a) Package quantity in one box : 16 pcs

b) Box Size : 425mm × 328mm × 350mm

9. PRECAUTIONS

Please pay attention to the followings when you use this TFT LCD module.

9-1. MOUNTING PRECAUTIONS

- (1) You must mount a module using holes arranged in four corners or four sides.
- (2) You should consider the mounting structure so that uneven force (ex. Twisted stress) is not applied to the module. And the case on which a module is mounted should have sufficient strength so that external force is not transmitted directly to the module.
- (3) Please attach the surface transparent protective plate to the surface in order to protect the polarizer. Transparent protective plate should have sufficient strength in order to resist external force.
- (4) You should adopt radiation structure to satisfy the temperature specification.
- (5) Acetic acid type and chlorine type materials for the cover case are not desirable because the former generates corrosive gas of attacking the polarizer at high temperature and the latter causes circuit break by electro-chemical reaction.
- (6) Do not touch, push or rub the exposed polarizers with glass, tweezers or anything harder than HB pencil lead. And please do not rub with dust clothes with chemical treatment. Do not touch the surface of polarizer for bare hand or greasy cloth. (Some cosmetics are detrimental to the polarizer.)
- (7) When the surface becomes dusty, please wipe gently with absorbent cotton or other soft materials like chamois soaks with petroleum benzene. Normal-hexane is recommended for cleaning the adhesives used to attach front / rear polarizers. Do not use acetone, toluene and alcohol because they cause chemical damage to the polarizer.
- (8) Wipe off saliva or water drops as soon as possible. Their long time contact with polarizer causes deformations and color fading.
- (9) Do not open the case because inside circuits do not have sufficient strength.

9-2. OPERATING PRECAUTIONS

- (1) The spike noise causes the mis-operation of circuits. It should be lower than following voltage :
 $V = \pm 200\text{mV}$ (Over and under shoot voltage)
- (2) Response time depends on the temperature. (In lower temperature, it becomes longer.)
- (3) Brightness depends on the temperature. (In lower temperature, it becomes lower.)
And in lower temperature, response time (required time that brightness is stable after turned on) becomes longer.
- (4) Be careful for condensation at sudden temperature change. Condensation makes damage to polarizer or electrical contacted parts. And after fading condensation, smear or spot will occur.
- (5) When fixed patterns are displayed for a long time, remnant image is likely to occur.
- (6) Module has high frequency circuits. Sufficient suppression to the electromagnetic interference shall be done by system manufacturers. Grounding and shielding methods may be important to minimize the interference.

※ If Customer supply incorrect Signal/Power, LPL cannot guarantee the Quality of LCM.

9-3. ELECTROSTATIC DISCHARGE CONTROL

Since a module is composed of electronic circuits, it is not strong to electrostatic discharge. Make certain that treatment persons are connected to ground through wrist band etc. And don't touch interface pin directly.

9-4. PRECAUTIONS FOR STRONG LIGHT EXPOSURE

Strong light exposure causes degradation of polarizer and color filter.

9-5. STORAGE

When storing modules as spares for a long time, the following precautions are necessary.

- (1) Store them in a dark place. Do not expose the module to sunlight or fluorescent light. Keep the temperature between 5°C and 35°C at normal humidity.
- (2) The polarizer surface should not come in contact with any other object.
It is recommended that they be stored in the container in which they were shipped.

9-6. HANDLING PRECAUTIONS FOR PROTECTION FILM

- (1) When the protection film is peeled off, static electricity is generated between the film and polarizer. This should be peeled off slowly and carefully by people who are electrically grounded and with well ion-blown equipment or in such a condition, etc.
- (2) The protection film is attached to the polarizer with a small amount of glue. If some stress is applied to rub the protection film against the polarizer during the time you peel off the film, the glue is apt to remain on the polarizer.
Please carefully peel off the protection film without rubbing it against the polarizer.
- (3) When the module with protection film attached is stored for a long time, sometimes there remains a very small amount of glue still on the polarizer after the protection film is peeled off.
- (4) You can remove the glue easily. When the glue remains on the polarizer surface or its vestige is recognized, please wipe them off with absorbent cotton waste or other soft material like chamois soaked with normal-hexane.