



ARM-Based Embedded Processor Device Overview

February 2001, ver. 1.2

Data Sheet

Features...



EXCALIBUR™

Preliminary Information



- Industry-standard ARM922T 32-bit RISC processor core operating at up to 200 MHz, equivalent to 210 Dhrystone MIPs
 - Memory management unit (MMU) included for real-time operating system (RTOS) support
 - ARMv4T instruction set with Thumb® extensions
- Part of the Altera® Excalibur™ embedded processor solutions: system-on-a-programmable-chip (SOPC) architecture (see [Figure 1](#) on page 4) builds upon features of the APEX™ 20KE family of programmable logic devices (PLDs), with up to 1,000,000 gates (see [Table 1](#) on page 2)
- Advanced memory configuration support
 - Harvard cache architecture with separate 64-way set associative 8-Kbyte instruction and 8-Kbyte data caches
 - Internal single-port SRAM up to 256 Kbytes
 - Internal dual-port SRAM up to 128 Kbytes
 - External SDRAM 133-MHz data rate (PC133) interface up to 512 Mbytes
 - External double data rate (DDR) 266-MHz data rate (PC266) interface up to 512 Mbytes
 - External flash memory; 4 devices, each up to 32 Mbytes
- Expansion bus interface (EBI) is compatible with industry-standard flash memory, SRAMs, and peripheral devices
- Advanced bus architecture based on AMBA™ high performance bus (AHB) capable of running at full processor speed
- Embedded programmable on-chip peripherals
 - ETM9 embedded trace module to assist software debugging
 - Flexible interrupt controller
 - Universal asynchronous receiver/transmitter (UART)
 - General-purpose timer
 - Watchdog timer
- PLD configuration/reconfiguration possible via the embedded processor software
- Integrated hardware and software development environment
 - Extended Quartus™ development environment for Excalibur support
 - Altera MegaWizard® Plug-In Manager interface configures the embedded processor, PLD, bus connections, and peripherals
 - C/C++ compiler, source-level debugger, and RTOS support

Table 1. Current ARM-Based Embedded Processor Device Features <i>Note (1)</i>			
Feature	EPXA1	EPXA4	EPXA10
Maximum system gates	263,000	1,052,000	1,772,000
Typical gates	100,000	400,000	1,000,000
LEs	4,160	16,640	38,400
ESBs	26	104	160
Maximum RAM bits	53,248	212,992	327,680
Maximum macrocells	416	1,664	2,560
Maximum user I/O pins	178	360	521
Single-port SRAM	32 Kbytes	128 Kbytes	256 Kbytes
Dual-port SRAM	16 Kbytes	64 Kbytes	128 Kbytes

Note:

(1) These features are preliminary. Contact Altera for up-to-date information.

- Advanced packaging options (see [Tables 2 and 3 on page 3](#))
- 1.8-V supply voltage, but all APEX 20KE I/O standards are supported
 - LVDS
 - SSTL-3
 - GTL+

... and More Features

- Fully configurable memory map
- Extensive embedded system debug facilities
 - SignalTap™ embedded logic analyzer
 - ARM EEE Std. 1149.1 (JTAG) processor debug support
 - Real-time data/instruction processor trace
 - Background debug monitoring via the JTAG interface
- Multiple and separate clock domains controlled by software-programmable phased-lock loops (PLLs) for embedded processor, SDRAM, and PLD
- PLL features include
 - ClockLock™ feature reducing clock delay and skew
 - ClockBoost™ feature providing clock multiplication

Feature	FineLine BGA			BGA	
	484 Pin	672 Pin	1,020 Pin	612 Pin	864 Pin
Pitch (mm)	1.00	1.00	1.00	1.27	1.27
Area (mm ²)	529	729	1,089	1,225	2,025
Length × Width (mm × mm)	23 × 23	27 × 27	33 × 33	35 × 35	45 × 45

Device	FineLine BGA			BGA	
	484 Pin	672 Pin	1,020 Pin	612 Pin	864 Pin
EPXA1	173	178		178	
EPXA4		275 (3)	360	215	360
EPXA10			521		365

Notes to tables:

- (1) Contact Altera for up-to-date information on package availability.
- (2) I/O counts include dedicated input and clock pins.
- (3) This device uses a thermally enhanced package, which is taller than the regular package. Consult the *Altera Device Package Information Data Sheet* for detailed package size information.



This document provides updated information about ARM®-based embedded processor devices and should be used together with the *APEX 20K Programmable Logic Device Family Data Sheet*.

General Description

Part of the Altera Excalibur embedded processor PLD solutions, the ARM-based embedded-processor PLDs combine an unrivalled degree of integration and programmability. The ARM-based devices are outstanding embedded system development platforms, providing embedded-processor and PLD performance that is leading edge, yet cost efficient.

The ARM-based family devices are offered in a variety of PLD device densities and memory sizes to fit a wide range of applications and requirements. Their high-performance, yet flexible, embedded architecture is ideal for compute-intensive and high data-bandwidth applications.

Figure 1 shows the structure of the ARM-based devices. The embedded processor stripe contains the ARM processor core, peripherals, and memory subsystem. The amount of single- and dual-port memory varies as shown, and as listed in Table 1 on page 2. Figure 2 on page 5 shows the system architecture of the stripe, and its interfaces to the PLD portion of the devices. This architecture allows stripe and PLD to be optimized for performance, enabling maximum integration and system cost reductions.

Figure 1. ARM-Based Embedded Processor PLD Architecture

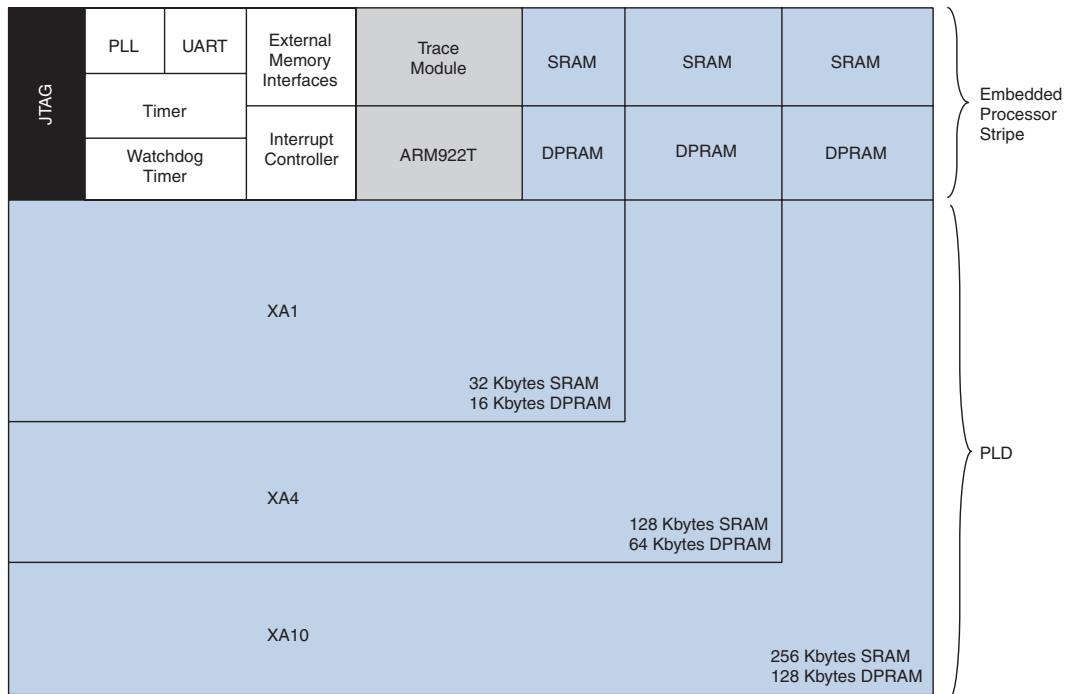
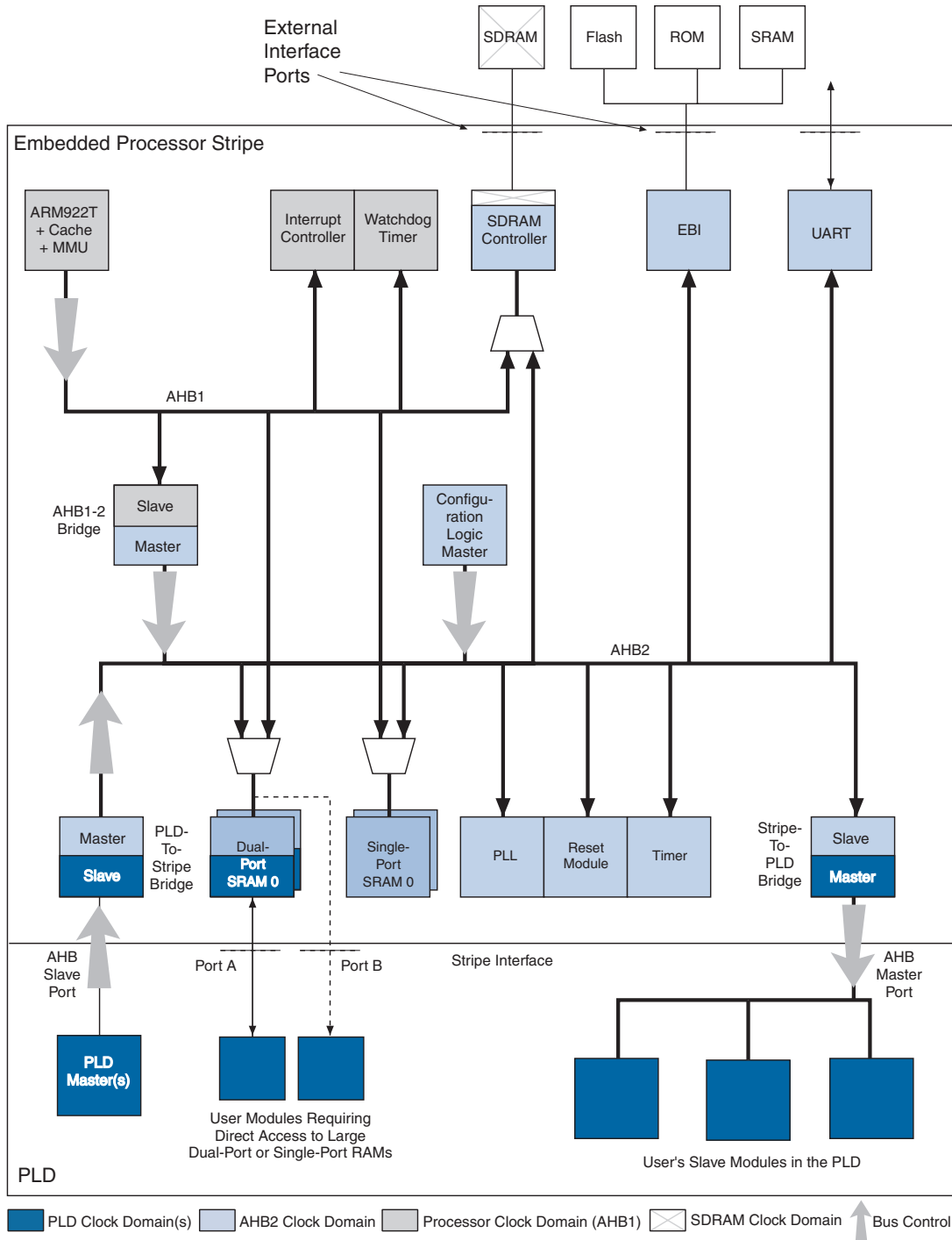

Figure 2. ARM-Based System Architecture



Two AMBA-compatible AHB buses ensure that ARM-based embedded processor activity is unaffected by peripheral and memory operation. Three bidirectional AHB bridges enable the peripherals and PLD to exchange data with the ARM-based embedded processor.

The performance of the ARM-based family is not compromised by the addition of the interfaces to or from the stripe, and is equivalent to an ASIC implementation of an ARM922T on a 0.18- μm CMOS process. The ARMv4T instruction set is binary-compatible with many other ARM family members.

ARM-based embedded processor devices are supported by Altera's Quartus development system. The Quartus software is a single, integrated package that offers HDL and schematic design entry, compilation and logic synthesis, full simulation and worst-case timing analysis, SignalTap logic analysis, and device configuration. The Quartus software runs on Windows-based PCs, Sun SPARCstations, and HP 9000 Series 700/800 workstations.

The Quartus software provides NativeLink™ interfaces to other industry-standard PC- and UNIX workstation-based EDA tools. For example, designers can invoke the Quartus software from within third-party design tools. Further, the Quartus software contains built-in optimized synthesis libraries; synthesis tools can use these libraries to optimize designs for ARM-based embedded processor devices.

Functional Description

The ARM-based embedded processor PLDs have a system architecture (embedded processor bus structure, on-chip memory, and peripherals) that combines the advantages of ASIC integration with the flexibility of PLDs.

ARM-Based Embedded Processor

Figure 3 shows the ARM-based embedded processor, the ARM922T.

Figure 3. ARM922T-Based Embedded Processor Internal Organization

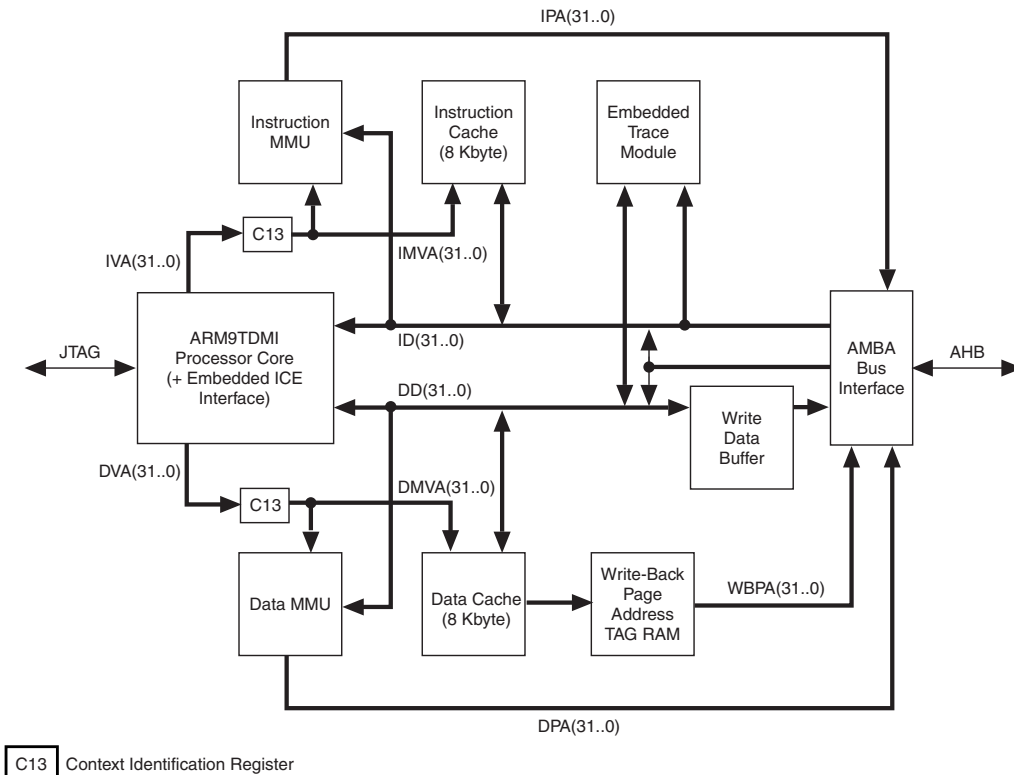

C13 Context Identification Register

The ARM922T is a member of the ARM9 Thumb family of processor cores, with Harvard architecture implemented using a five-stage pipeline. This implementation allows single clock-cycle instruction operation through simultaneous fetch, decode, execute, memory, and write stages. It supports both the 32-bit ARM and 16-bit Thumb instruction sets, allowing users to achieve a balance between high code density and performance.

Independent of PLD configuration, the embedded processor can undertake the following activities:

- Access external boot memory
- Boot and run

- Program/reprogram the PLD without corruption of memory
- Run interactive debugging
- Detect errors and restart/reboot/reprogram the entire system as necessary
- Communicate with the external world and receive PLD updates
- Run a real-time operating system

PLD Interfaces

The PLD can be configured via the configuration interface or the embedded processor to implement various devices:

- Additional peripherals that connect to the embedded bus as masters, slaves, or both
- Coprocessors sharing the stripe as well as on-chip and off-chip memories
- Standard interface to on-chip dual-port RAM (allowing SRAM to function as a 'large' embedded system block (ESB))
- Additional embedded processor interrupt sources and controls

The master/slave/memory ports are synchronous to the separate PLD clock domains that drive them; however, the embedded processor domain and PLD domain can be asynchronous, to allow optimized clock frequencies for each domain. Resynchronization across the domains is handled by the AHB bridges within the stripe.

Both the master port and slave port of the stripe are capable of supporting 32-bit data accesses to the whole 4-Gbyte address range (32-bit address bus).

The PLD can take full advantage of the extensive range of Altera intellectual property (IP) MegaCore[®] functions, reducing time-to-market and enabling complex SOPC designs.

PLLs

The device PLLs build on the PLL features of the APEX 20KE devices.

Within the PLD, four PLLs are available as in the APEX devices. In addition to the four APEX PLLs, ARM-based embedded processor PLDs have two ClockBoost PLLs that are frequency-programmable—both at configuration and via the system bus—to provide clocks for the following devices:

- Embedded processor and associated modules
- Memory controller

The additional PLLs and associated routing support the following features:

- A common source for running additional PLLs
- Clock generation for the embedded processor and memory subsystem, allowing a synchronous mode
- LVTTTL 2.5-V and 3.3-V clock input
- PLL disabling, which allows the raw input clock to be routed as the main clock source

The memory controller PLL allows users to tune the frequency of the system clock to the speed of the external memory implemented in their systems.

External Memory Controllers

The ARM-based embedded processor PLDs provide two embedded memory controllers that can be accessed by any of the bus masters: one for external SDRAM, and a second for external flash memory or SRAM.

The SDRAM memory controller supports the following commonly-available memory standards, without the addition of any glue logic:

- Single data rate (SDR) 133-MHz data rates
- Double data rate (DDR) 266-MHz data rates

A software-programmable PLL is used within the SDRAM memory controller subsystem to supply the appropriate timings. Users can program the frequency to match the chosen memory components.

A second memory controller supports the interface to system ROM, allowing external flash memory access and reprogramming. In addition, static RAM and simple peripherals can be connected to this interface externally.

Software Development Tools

Peripherals

The following peripherals are connected to the AHB:

- UART
- Timer
- Watchdog timer
- Interrupt controller

The target software development tools offered by Altera are based on a combination of new tools, plus selected existing Altera and ARM developer suite (ADS) tools. The ARM-based embedded processor PLDs are compatible with any available tools from ARM or third parties for the ARM922T.

The Altera development tools include:

- Support from industry-leading tools, including ADS, GNU and Wind River. See the Altera web site for details.
- Quartus support
 - C/C++ text editor
 - Software mode to build applications

For details of third-party support, see *Third-Party Tool Support for the Family of ARM-Based Embedded Processor PLDs*.

Figure 4 shows the Quartus development tool flow.

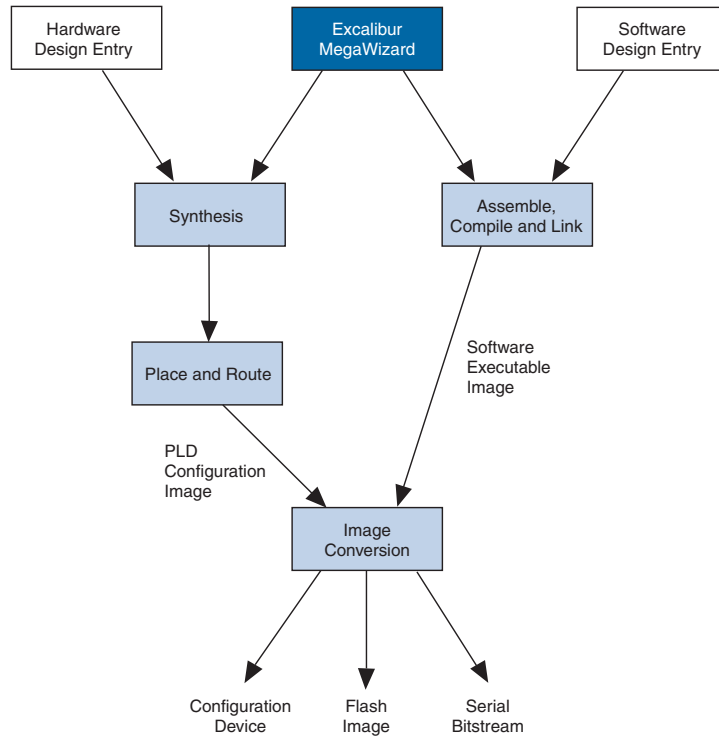
Figure 4. Quartus Development Tool Flow

Altera supplies a variety of embedded software functions to support flash memory programming and PLD configuration.

In addition, Altera provides device drivers for on-chip peripherals, and drivers to support PLD logic peripherals.

ARM-based embedded processor PLDs are configured at system power-up with data stored in a configuration device or flash memory. The same memory can store application software for the embedded processor. The user can reconfigure the device in-circuit by using the on-chip processor, using configuration data stored anywhere in its memory system. The user can make real-time changes during system operation, which enables innovative reconfigurable computing applications.

Configuration Wizard

The Altera Quartus development environment is enhanced by an Excalibur configuration wizard that allows pre-runtime setup of hardware and software functions. [Figure 5](#) presents a typical set of screen shots from the configuration wizard, showing how users can, for example, select clock frequencies and booting options, and specify peripherals. This information is used to prepare a configuration bitstream that configures the PLD setup registers and on-chip SRAM as part of the configuration bitstream.

Figure 5. Excalibur Configuration Wizard

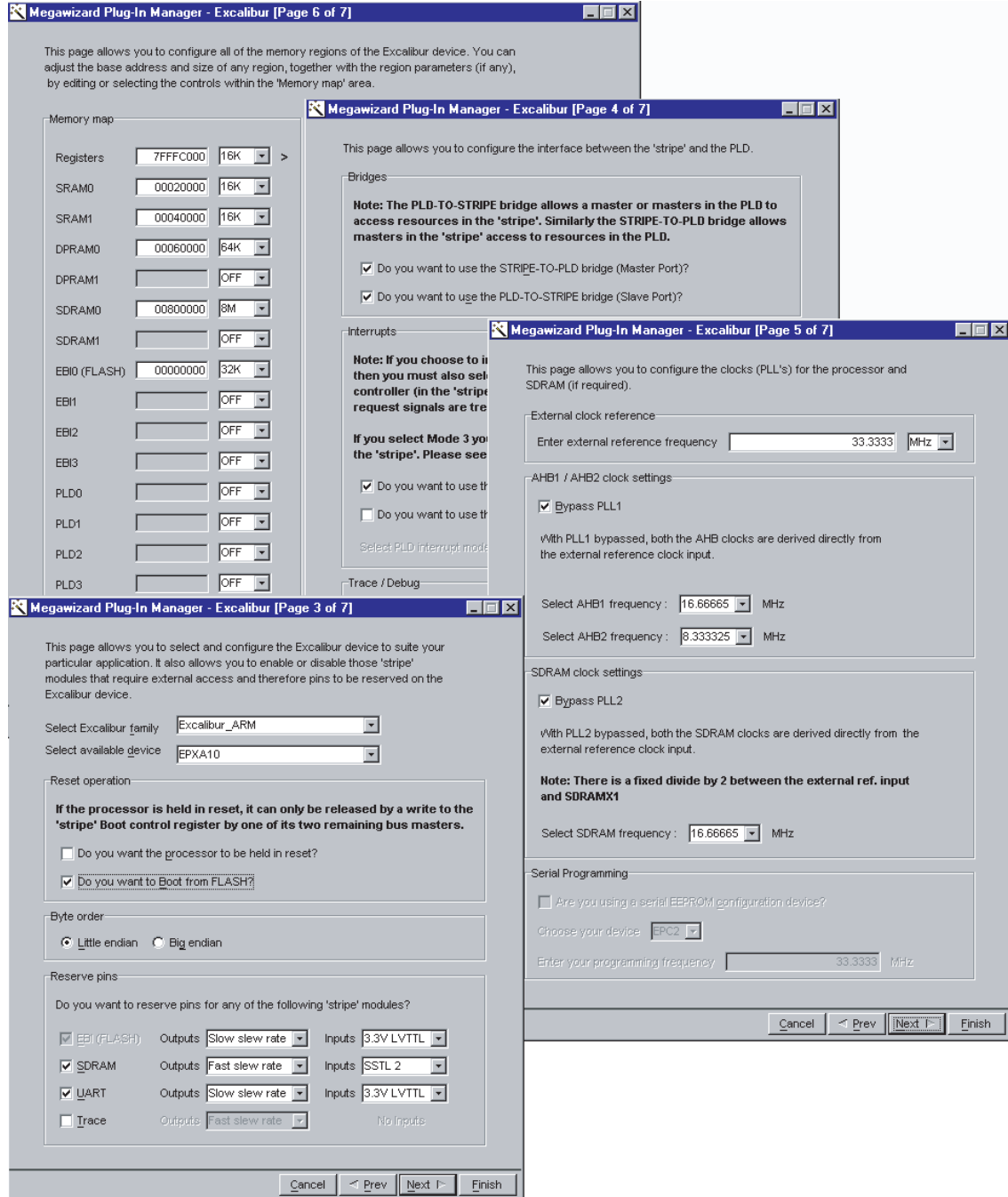

Trace

A trace port provided on the ETM9 is compatible with the external trace analysis tools. This feature allows real-time visibility of embedded processor execution, and is tightly integrated with the source-level debugging tools.

Simulation Model

Initial simulation models of the ARM922 are compatible with the following simulators:

- Quartus simulator
- Verilog XL simulator
- ModelSim simulator
- Synopsys VSS simulator

Evaluation Board

Altera offers separately an evaluation board compatible with the ARM-based embedded processor PLD, along with high-performance memories, debug interfaces, PCI bus connections, and capability for prototyping physical interfaces. [Figure 6](#) illustrates the Altera evaluation board, showing the provision for board expansion.

Figure 6. ARM-Based Evaluation Board

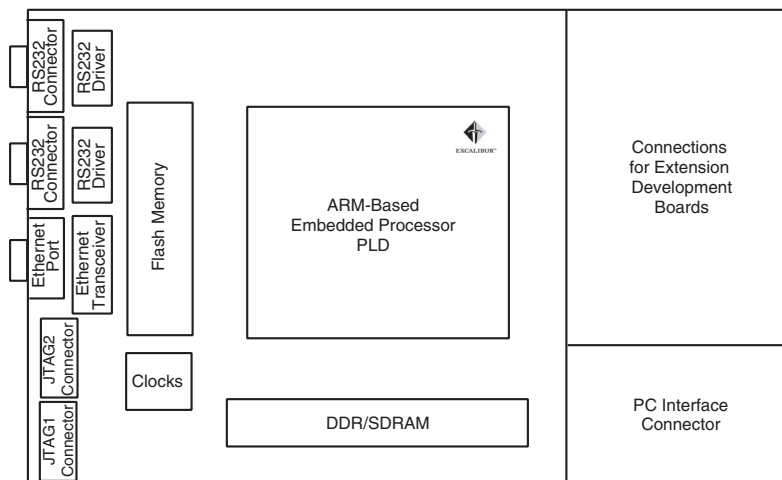

Typical Application

Figure 7 shows how the ARM-based embedded processor and other elements can be integrated on a device. In this example, the ARM-based embedded processor device is configured for a voice-over packet gateway application. The elements of the embedded processor stripe, PLD modules, and off-chip peripherals are clearly identified.

Figure 7. ARM-Based Embedded Processor Device in a Voice-Over Packet Gateway Application

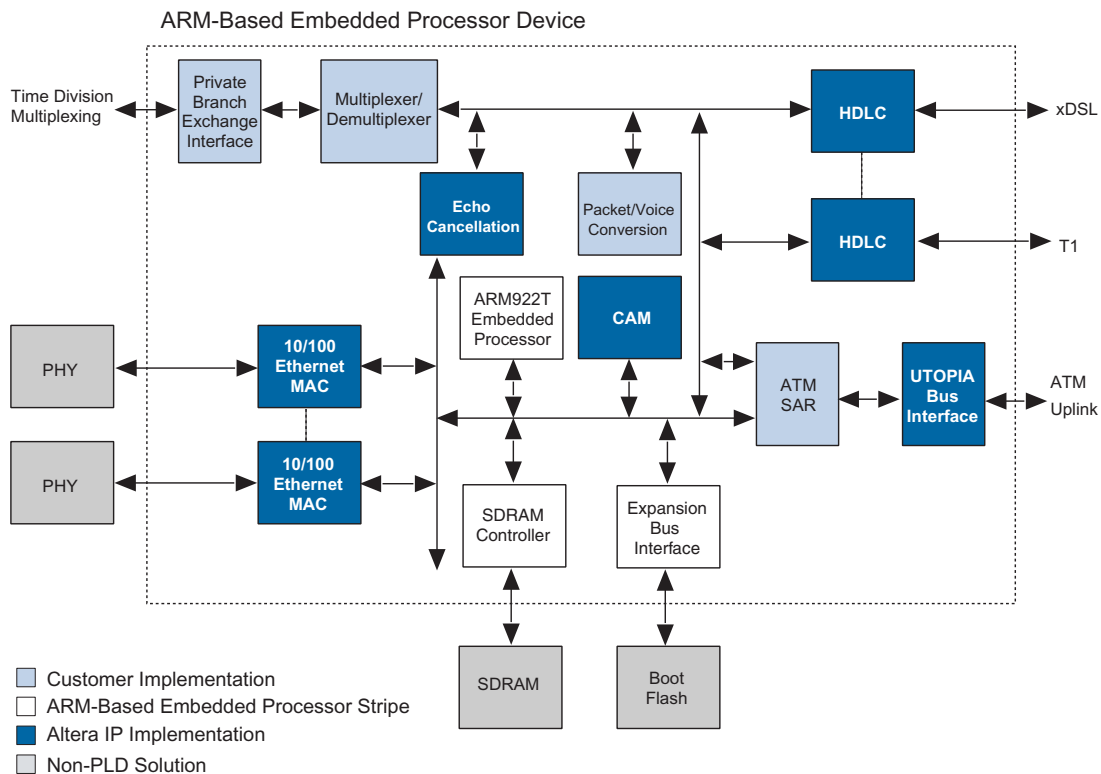

Revision History

This document provides updated information as described below.

Version 1.2

This version provides updated information, including:

- Operating speed and other device features
- Updated system architecture (Figure 2)
- Minor textual changes

Version 1.1

This version provides updated information, including:

- Revised maximum amount of external SDRAM supported
- Minor formatting and textual changes



101 Innovation Drive
San Jose, CA 95134
(408) 544-7000
<http://www.altera.com>
[Applications Hotline:](#)
(800) 800-EPLD
[Customer Marketing:](#)
(408) 544-7104
[Literature Services:](#)
lit_req@altera.com

Altera, APEX, ClockBoost, ClockLock, ClockShift, Excalibur, FineLine BGA, MegaCore, MegaWizard, NativeLink, Quartus, SameFrame, and SignalTap are trademarks and/or service marks of Altera Corporation in the United States and other countries. Altera acknowledges the trademarks of other organizations for their respective products or services mentioned in this document, including the following: ARM, Thumb and the ARM-Powered logo are registered trademarks of ARM Limited. Altera products are protected under numerous U.S. and foreign patents and pending applications, maskwork rights, and copyrights. Altera warrants performance of its semiconductor products to current specifications in accordance with Altera's standard warranty, but reserves the right to make changes to any products and services at any time without notice. Altera assumes no responsibility or liability arising out of the application or use of any information, product, or service described herein except as expressly agreed to in writing by Altera Corporation. Altera customers are advised to obtain the latest version of device specifications before relying on any published information and before placing orders for products or services.

Copyright © 2001 Altera Corporation. All rights reserved.



I.S. EN ISO 9001